

T-7 Fassade

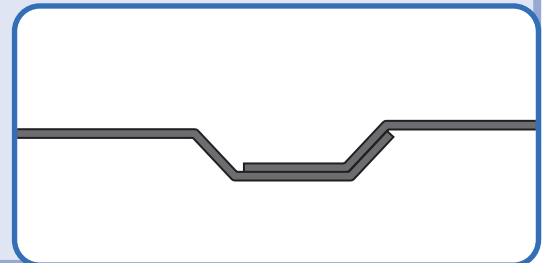

T-7 PRO

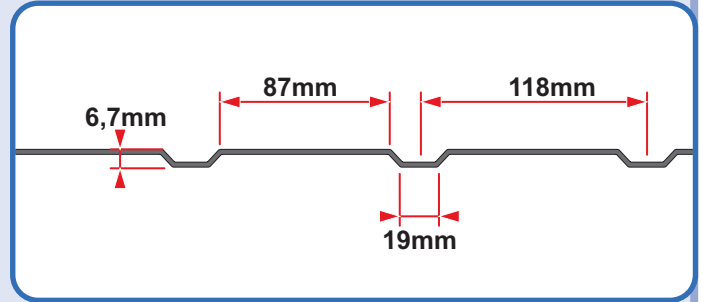
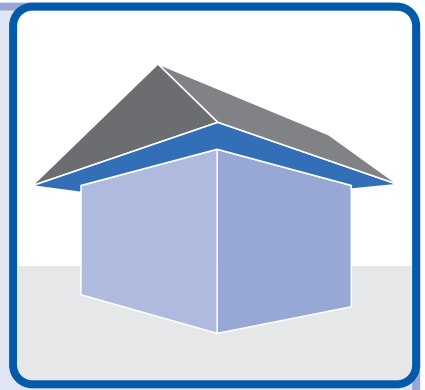
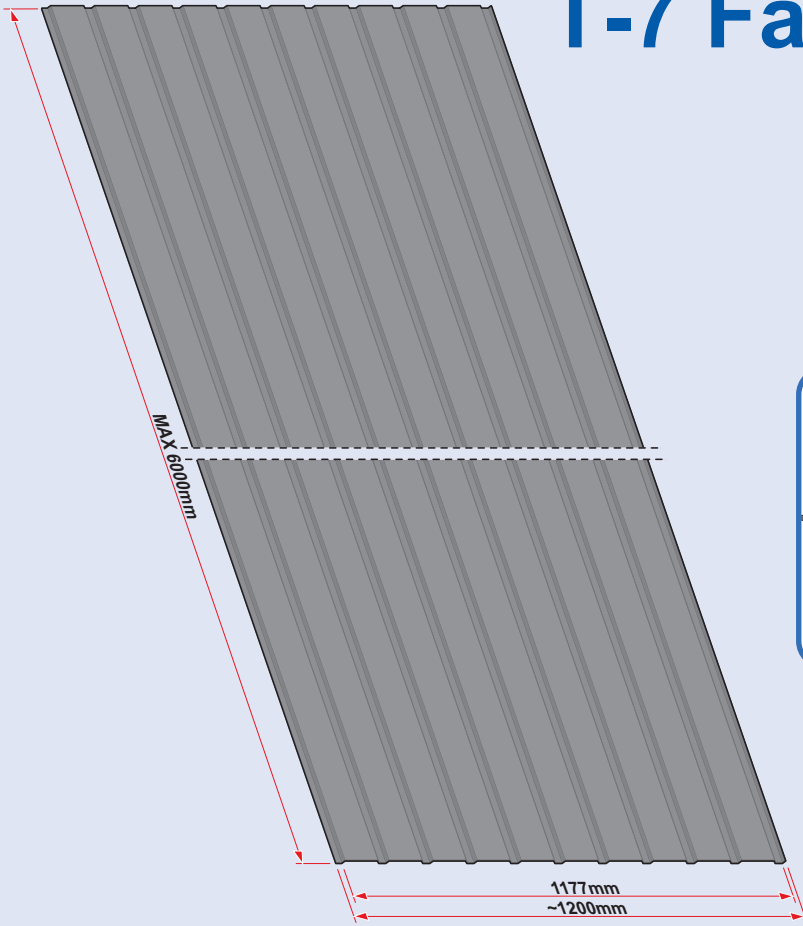
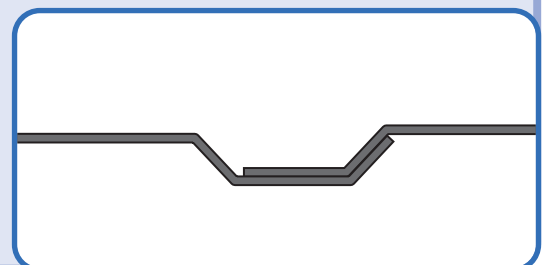
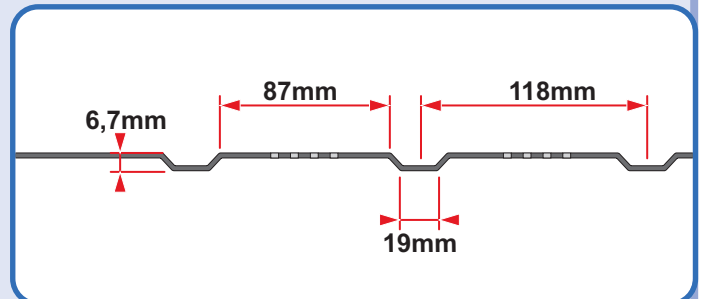
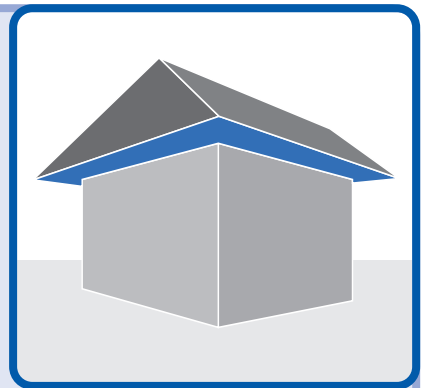
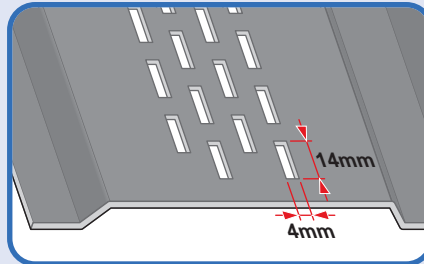
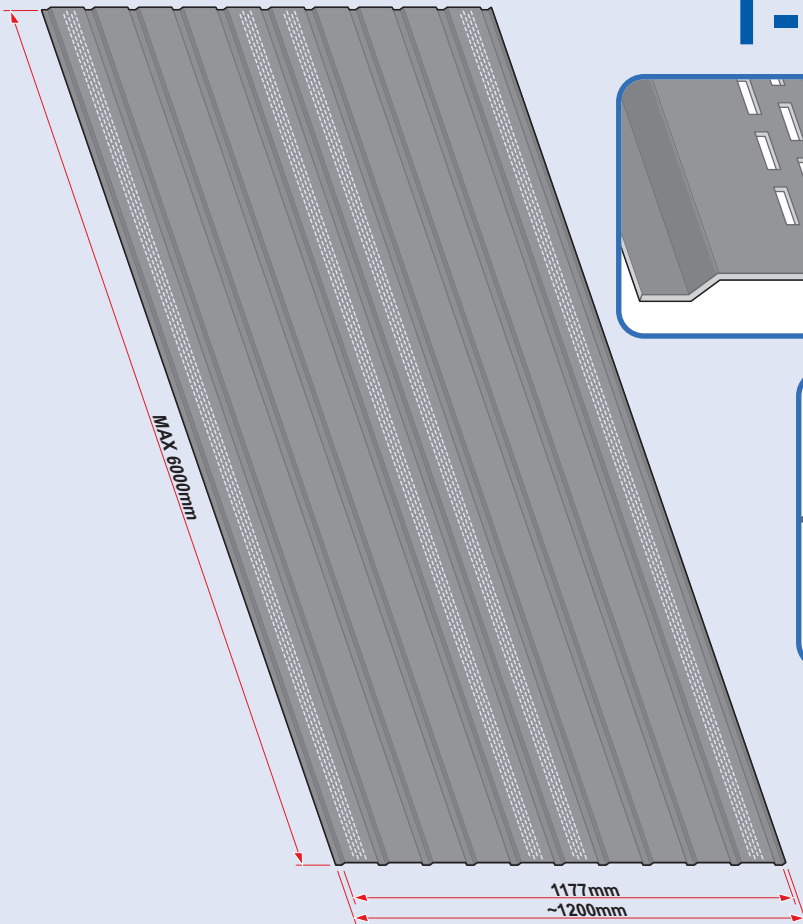

Vorgeschlagene Musterabmessungen

1

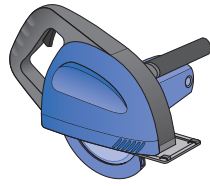
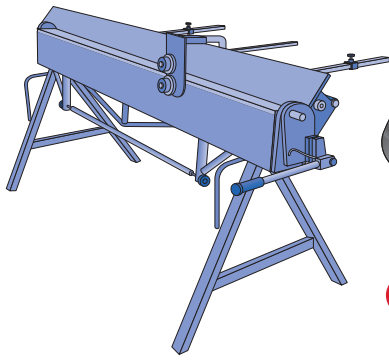

max. 4000 U/min

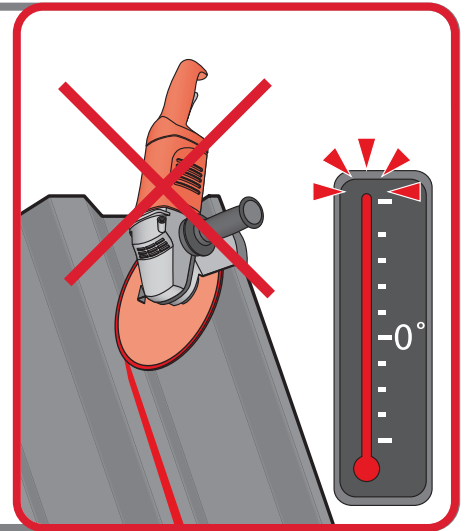
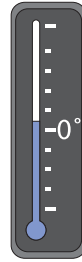
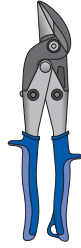
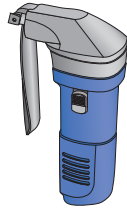

2

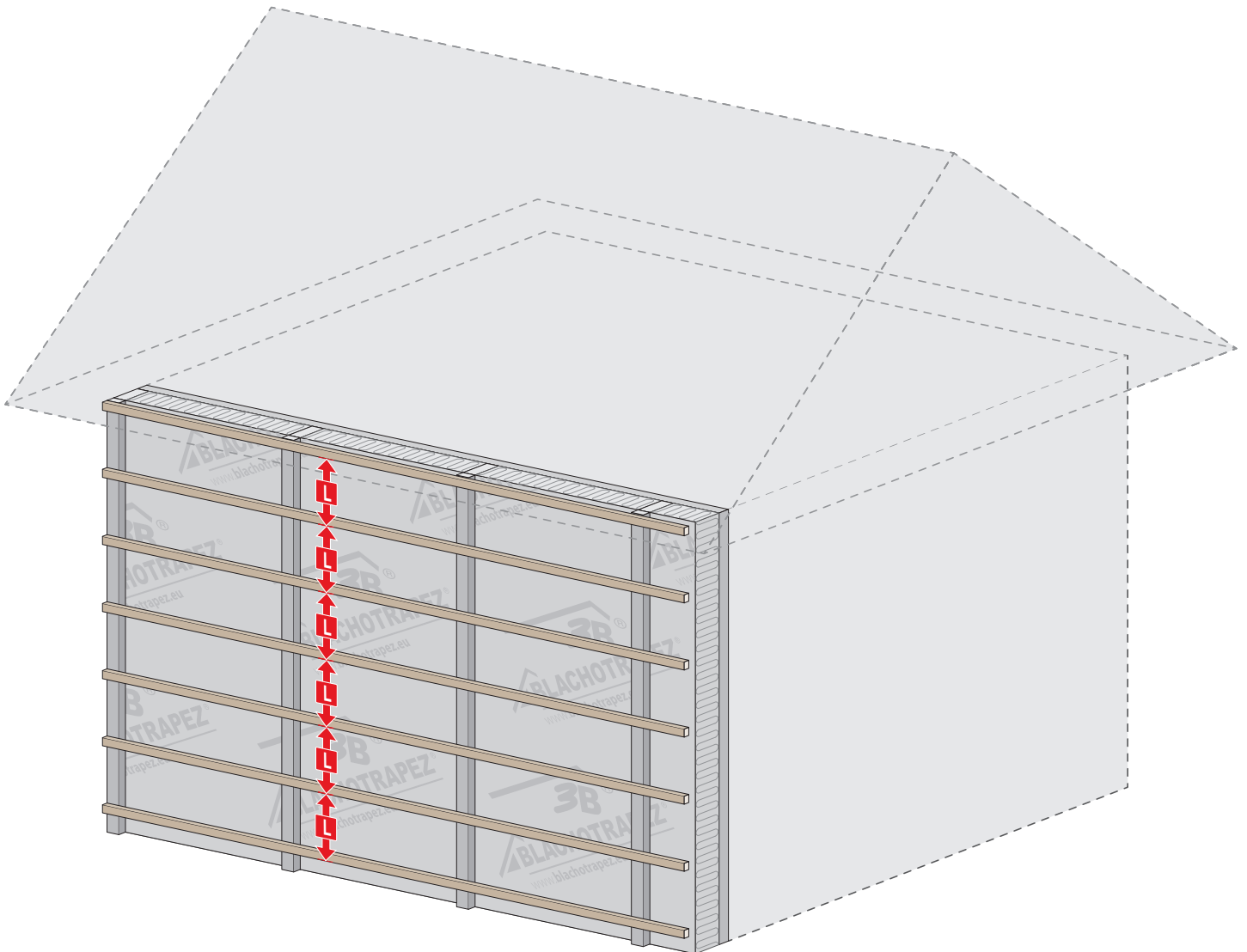

Abstand (L) gemäß Projekt. Hängt von der Art der Konstruktion, der Kerndicke, der Länge der Bleche und der Region ab.

3a

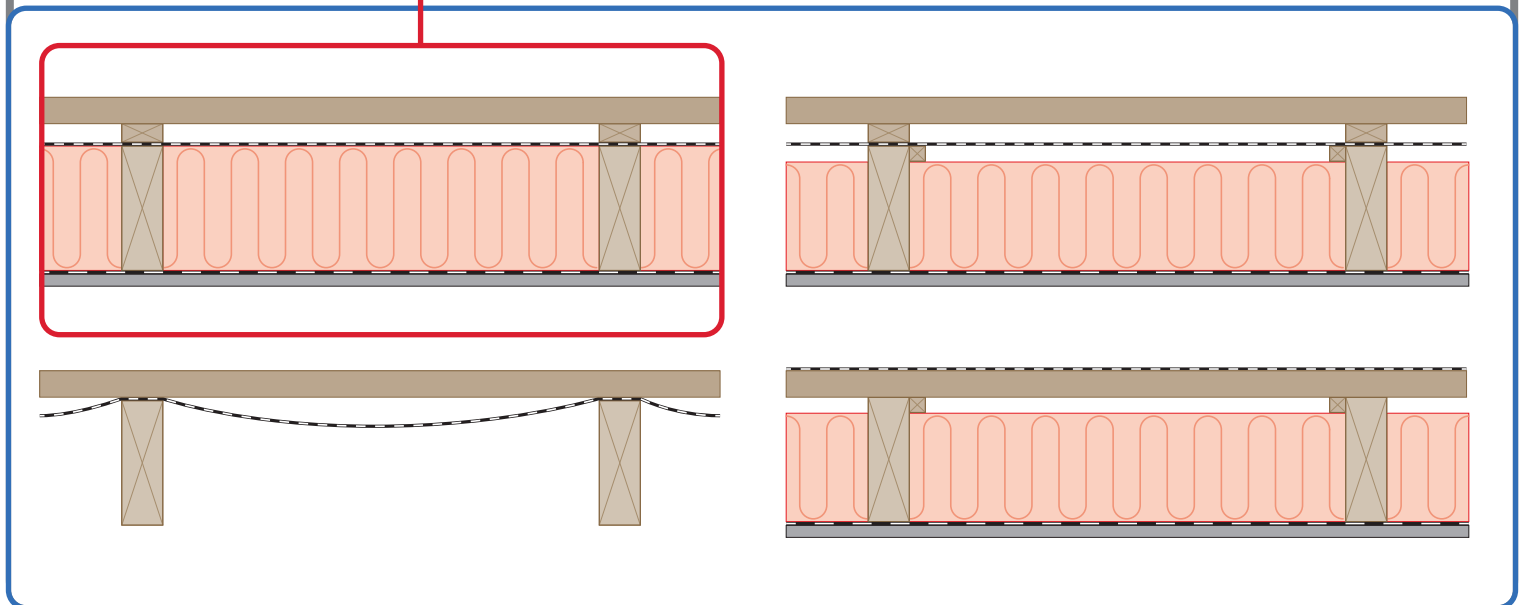
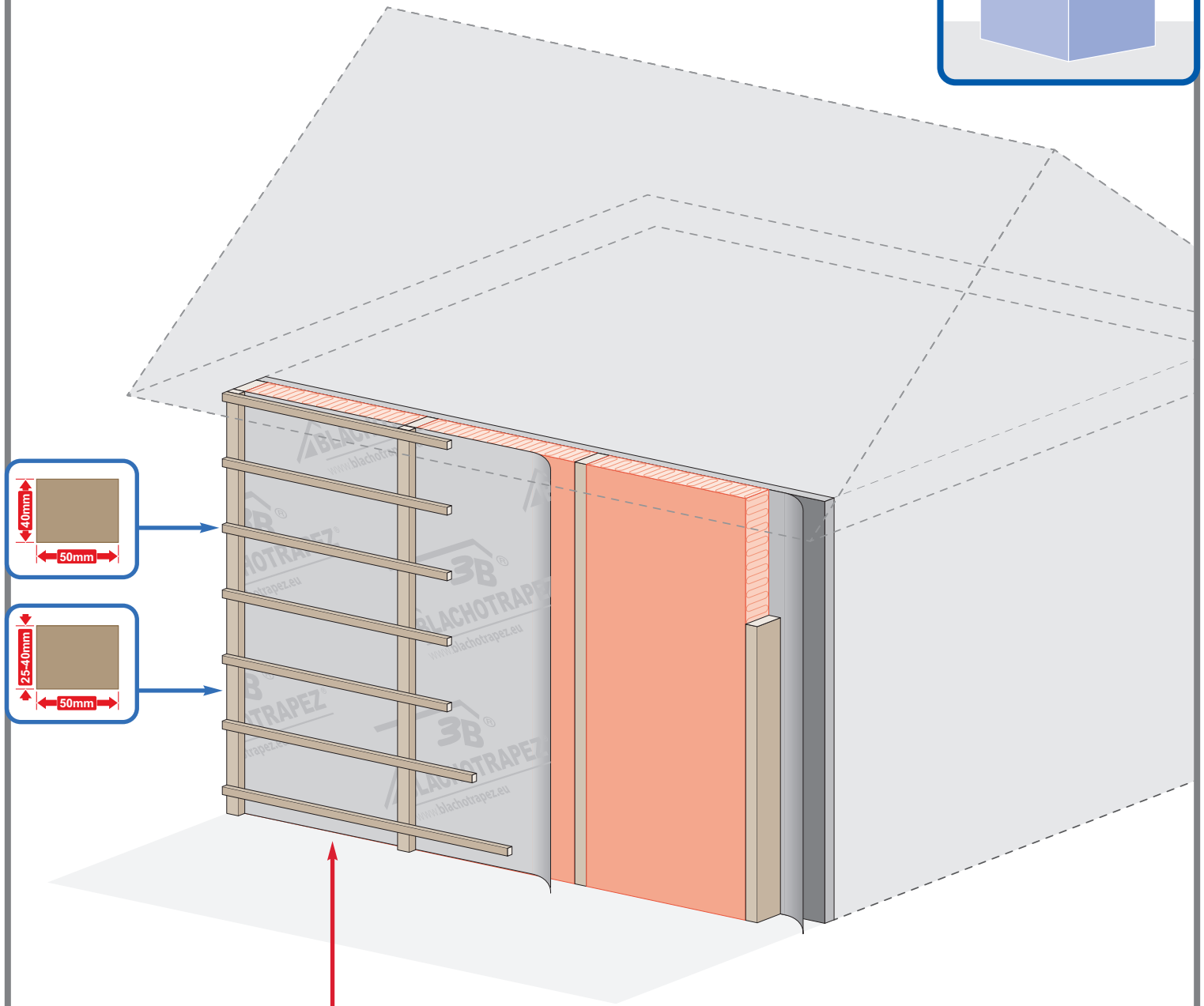
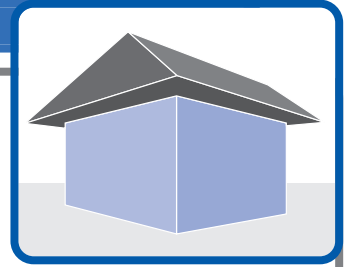

3b

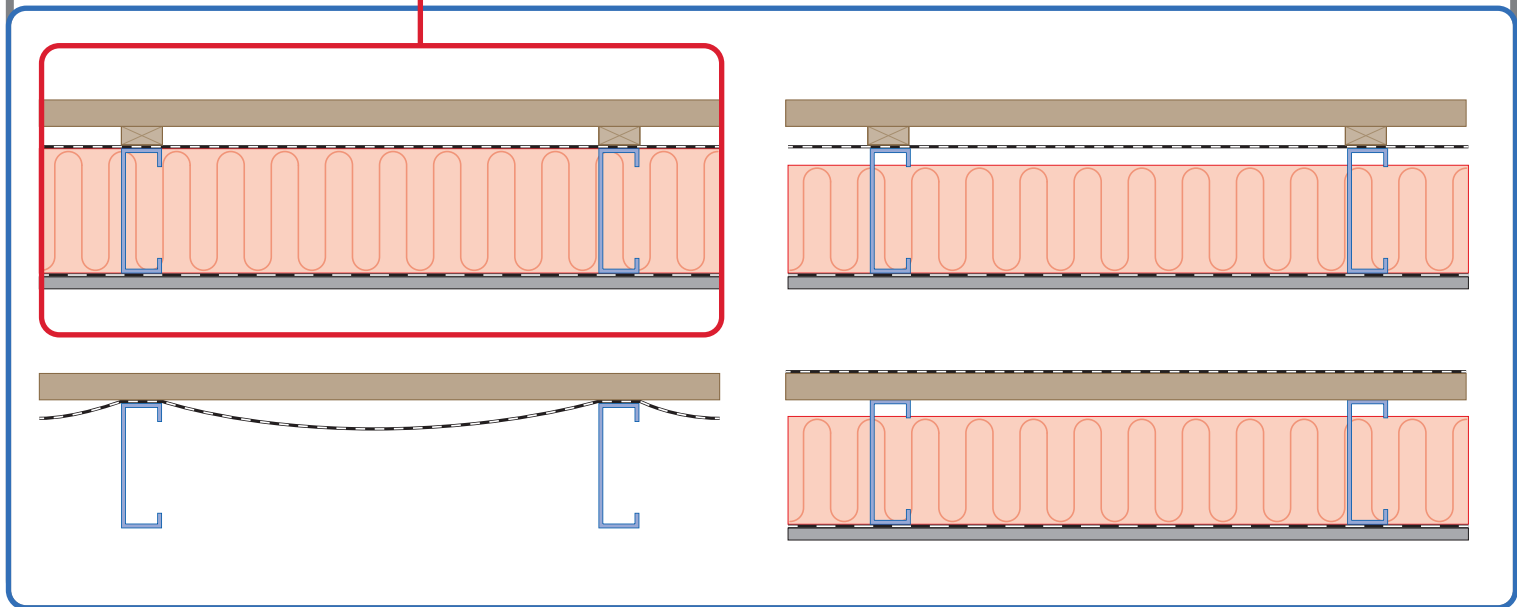
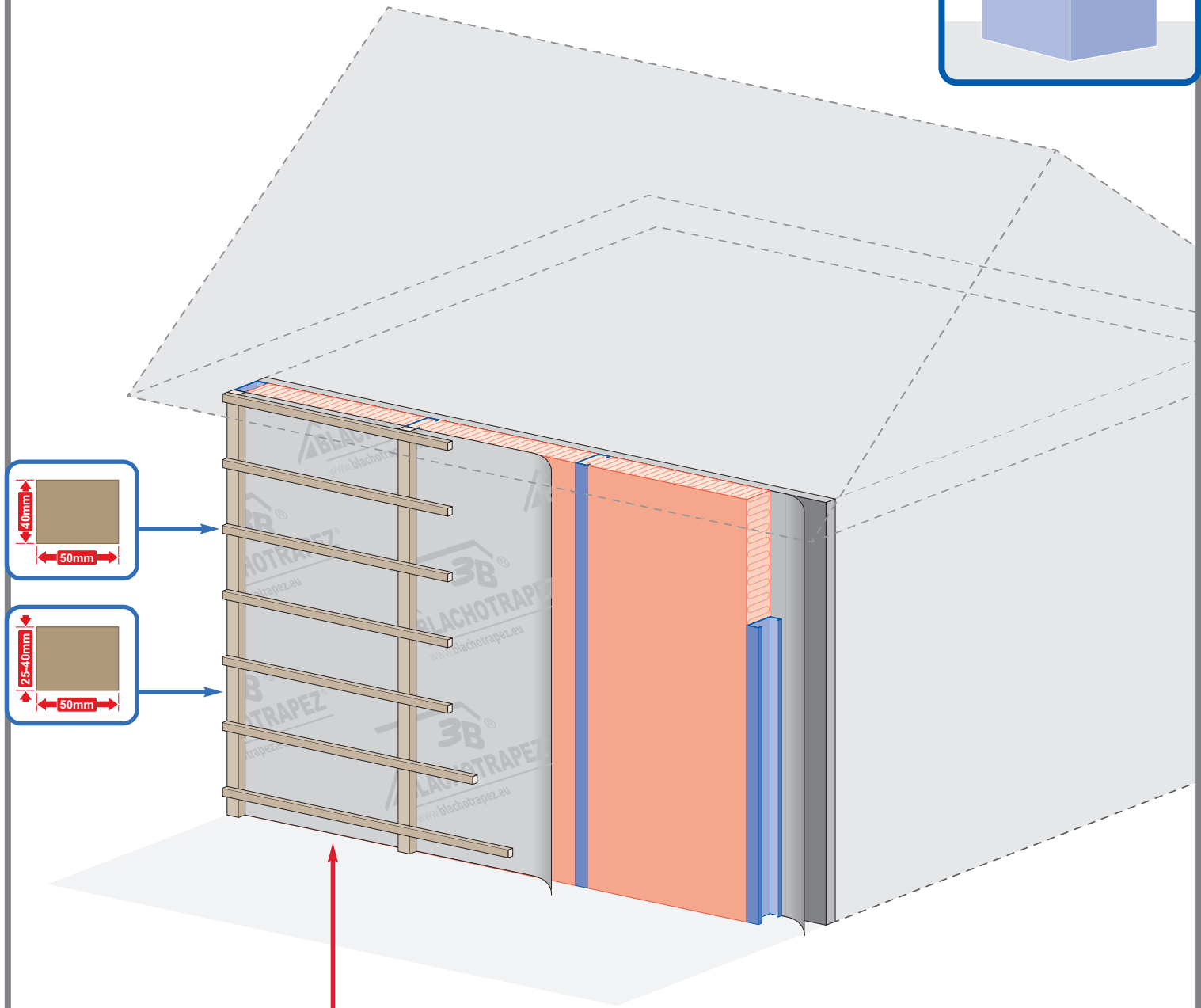
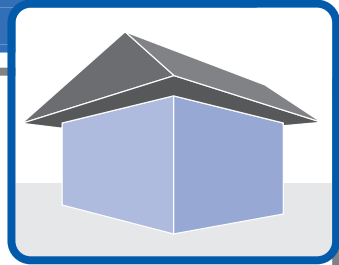

3c

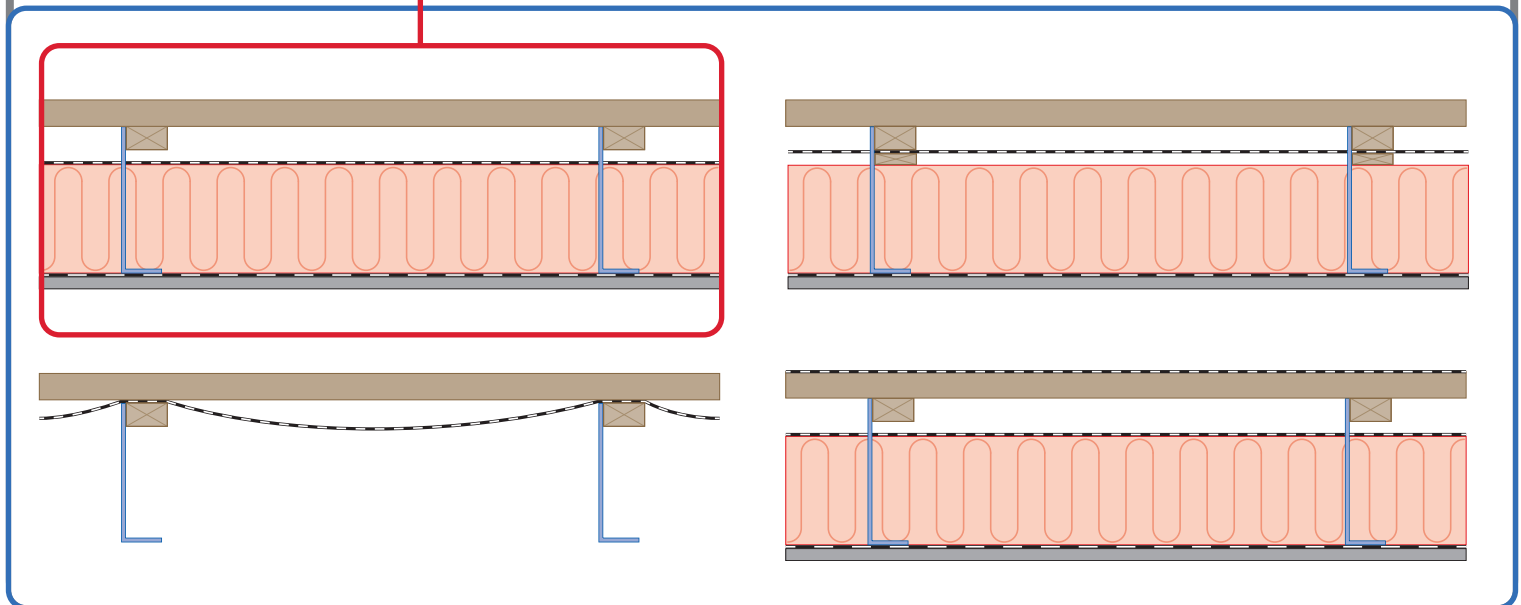
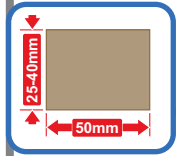
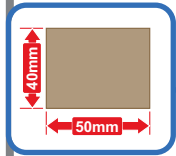
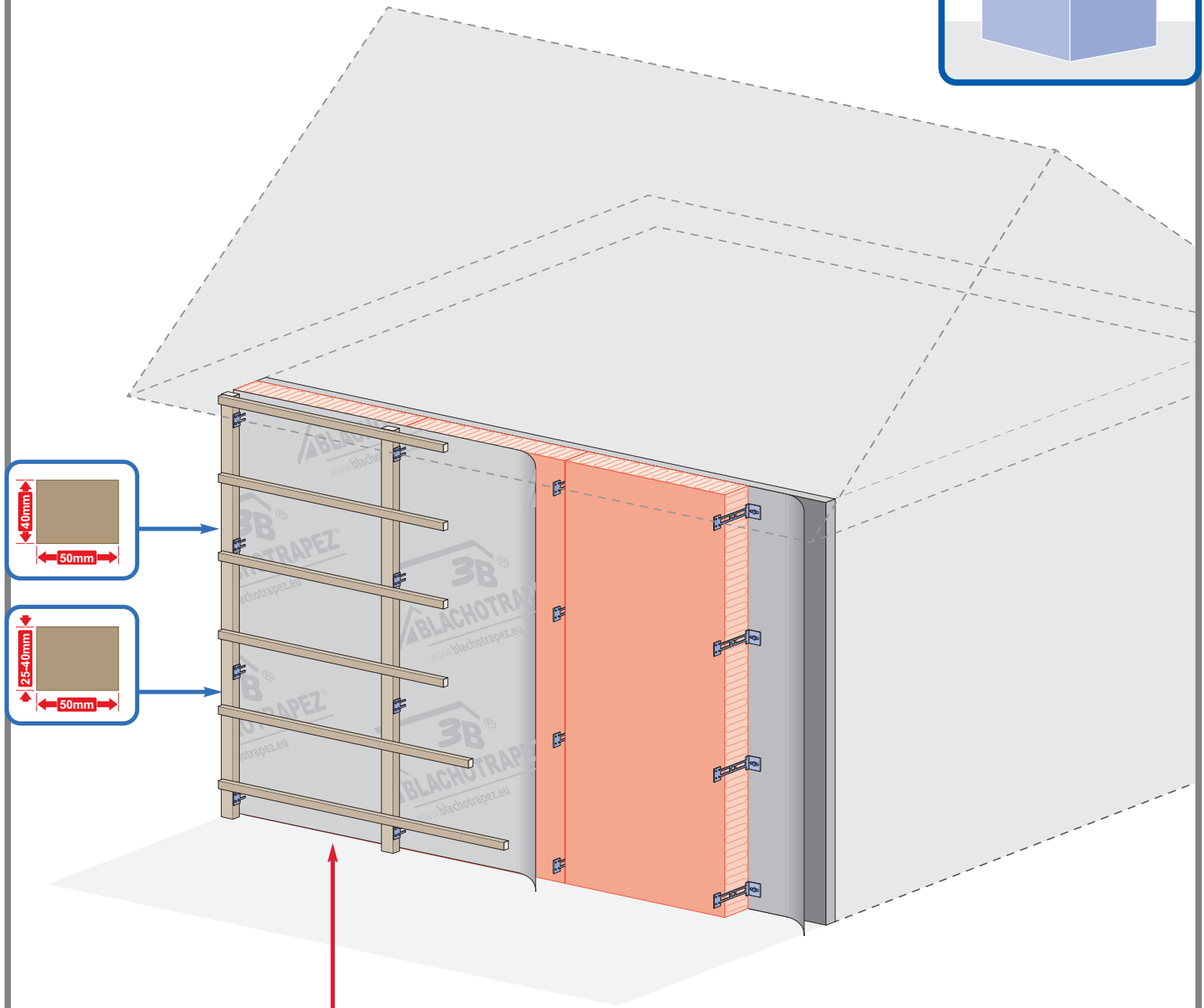
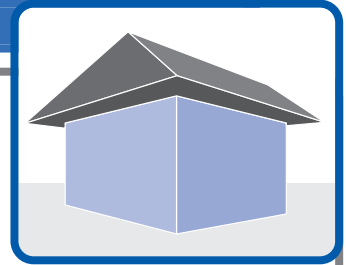

4a

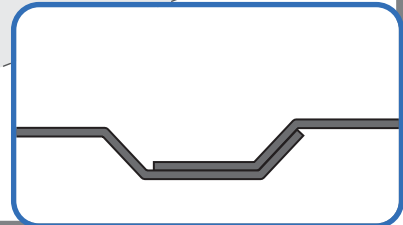
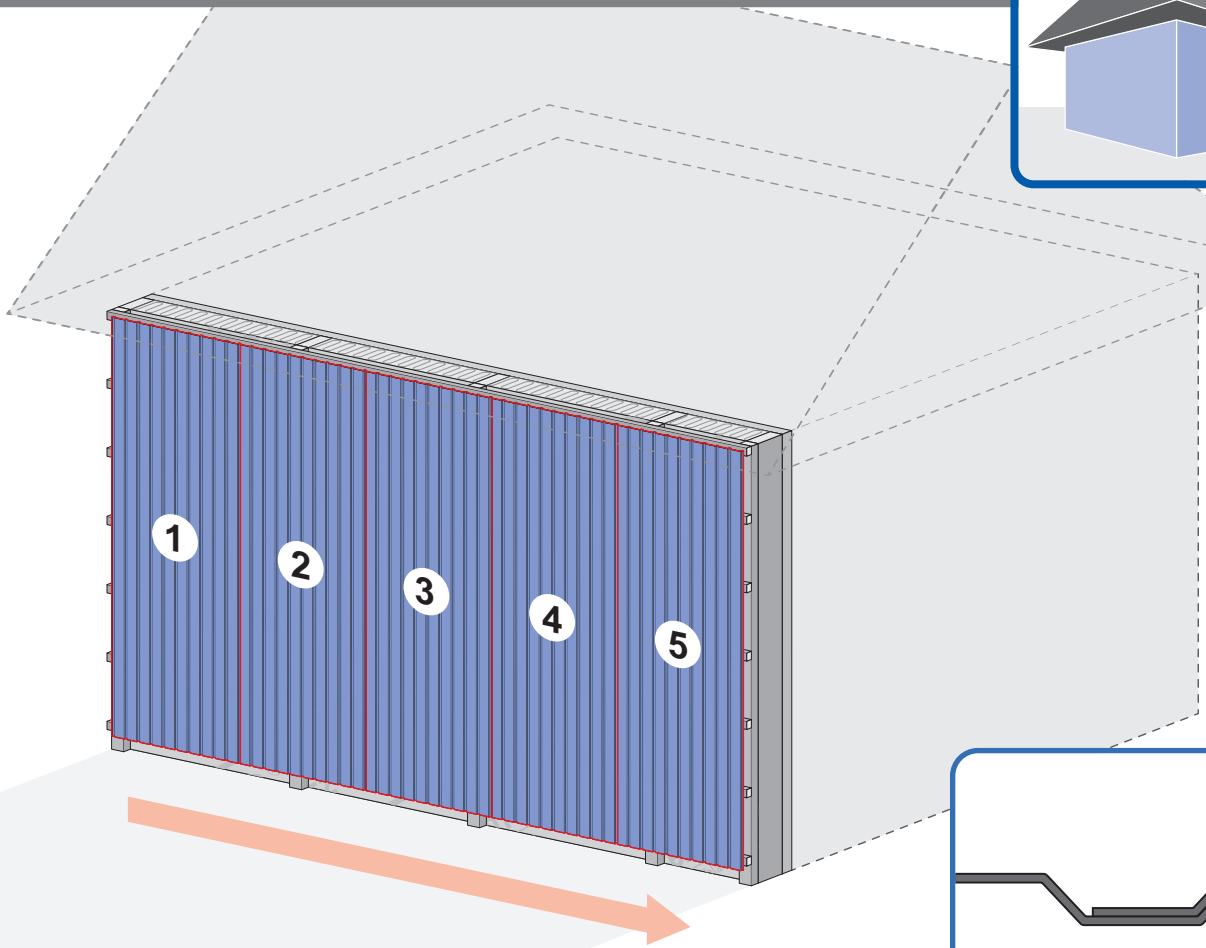
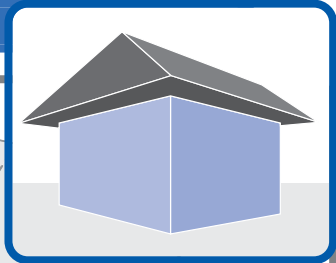

4b

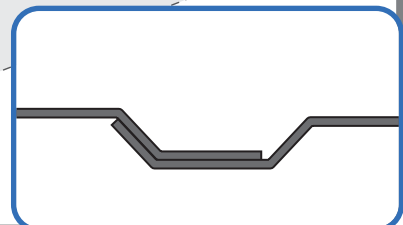
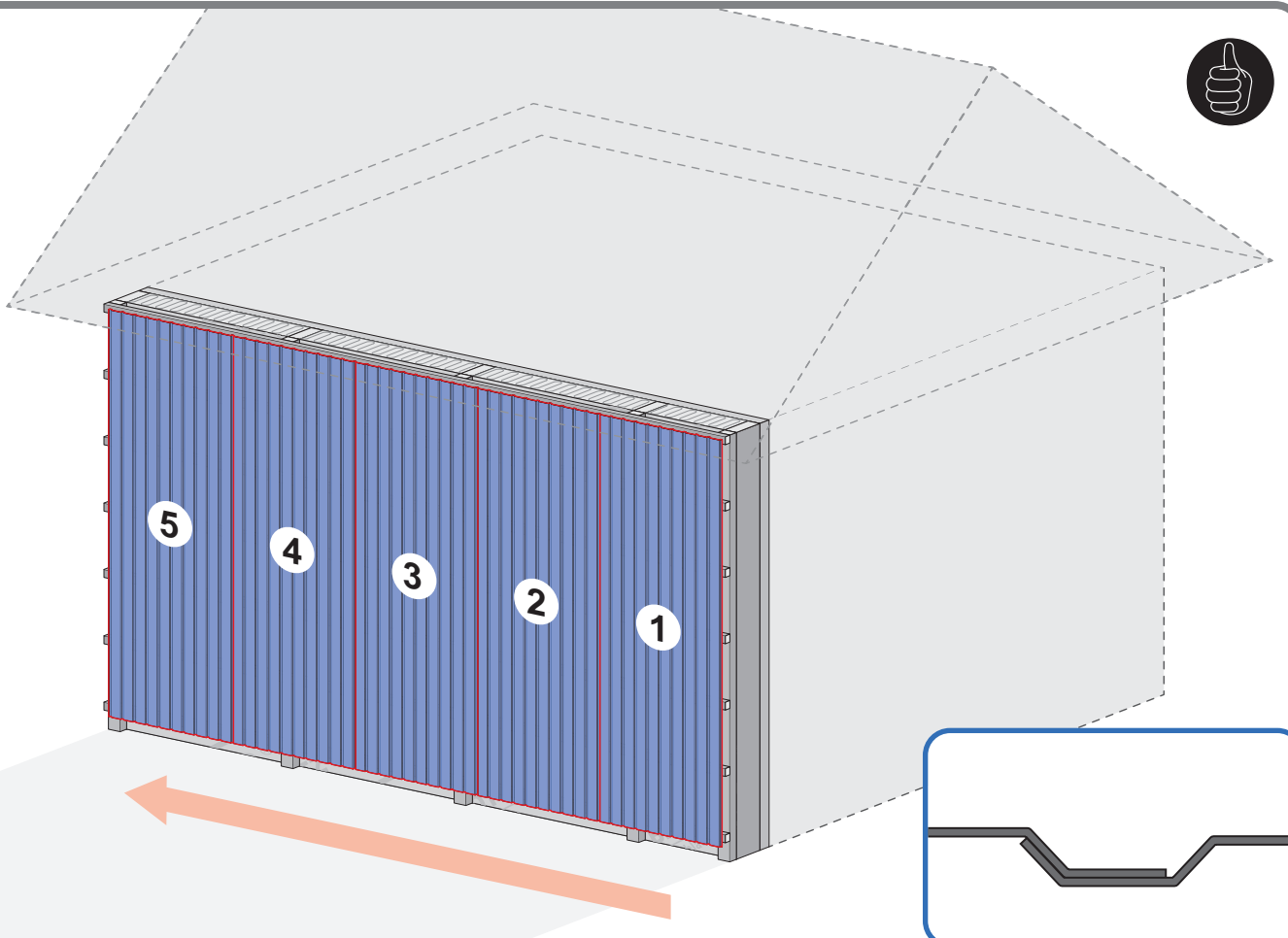

4c

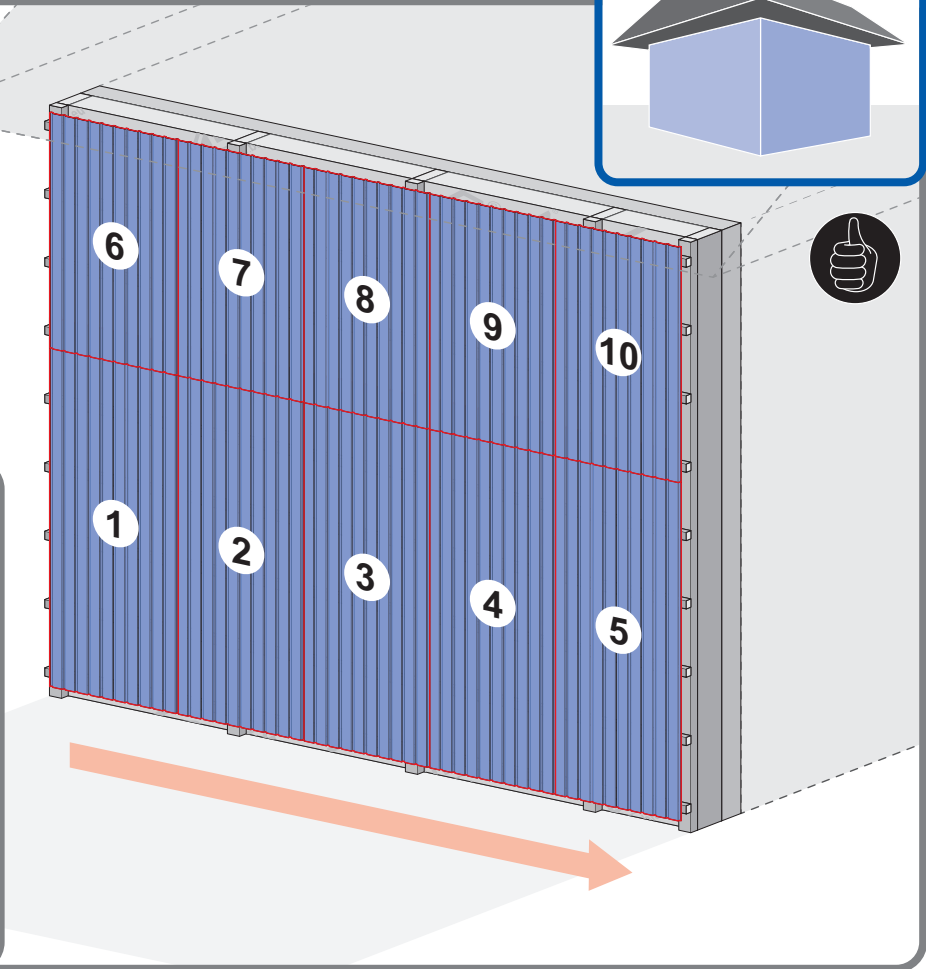
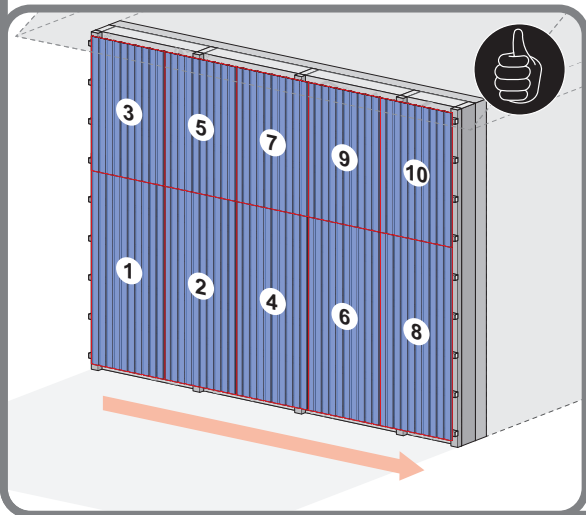
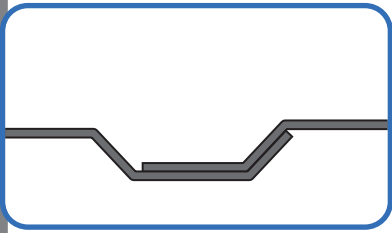
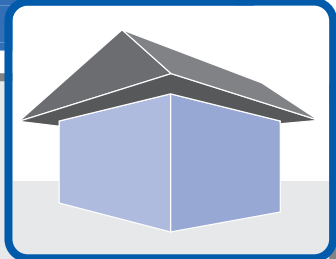

4d

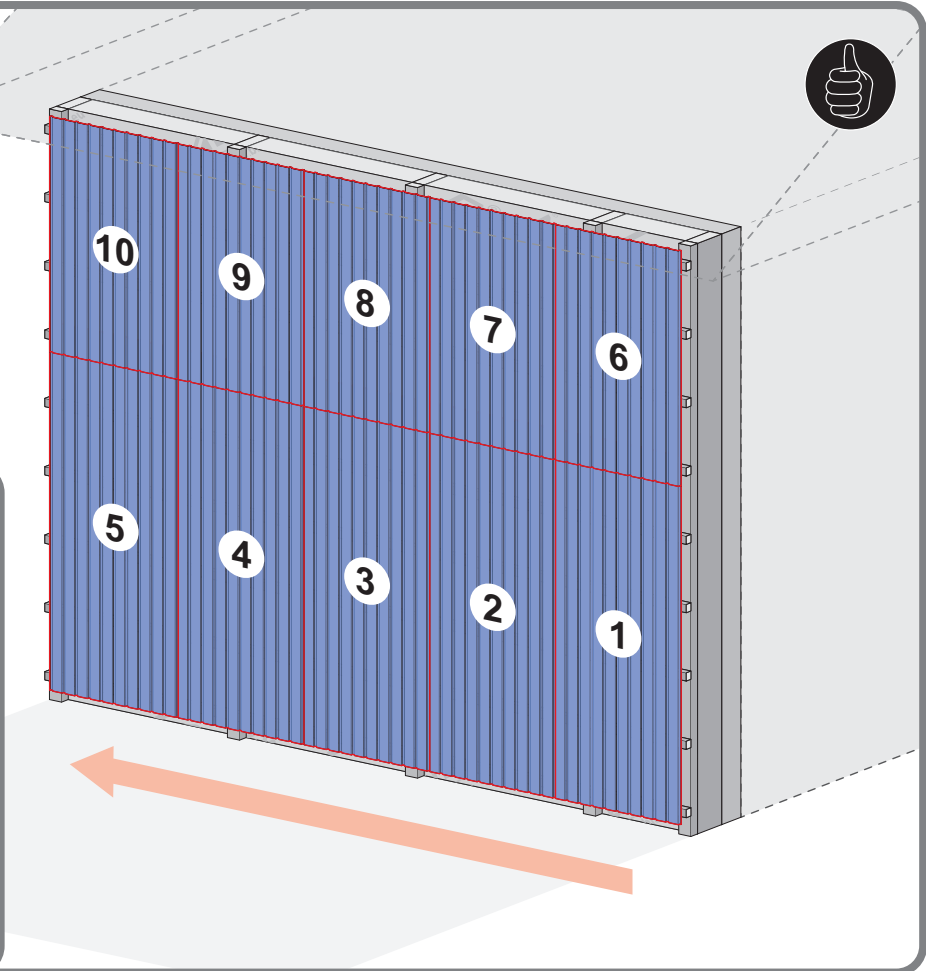
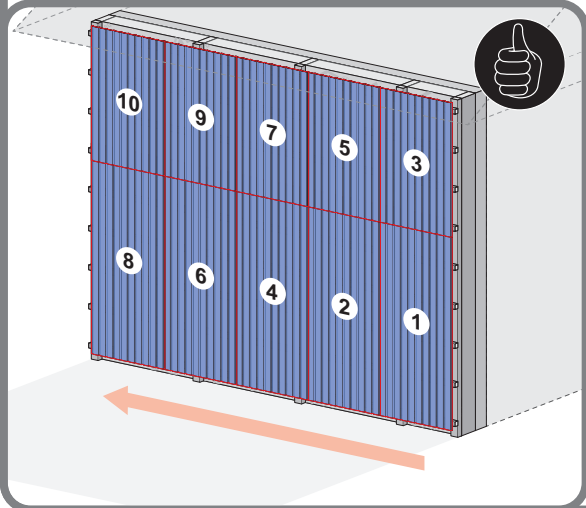
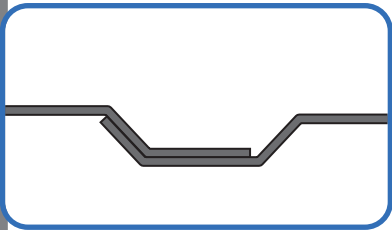

5a

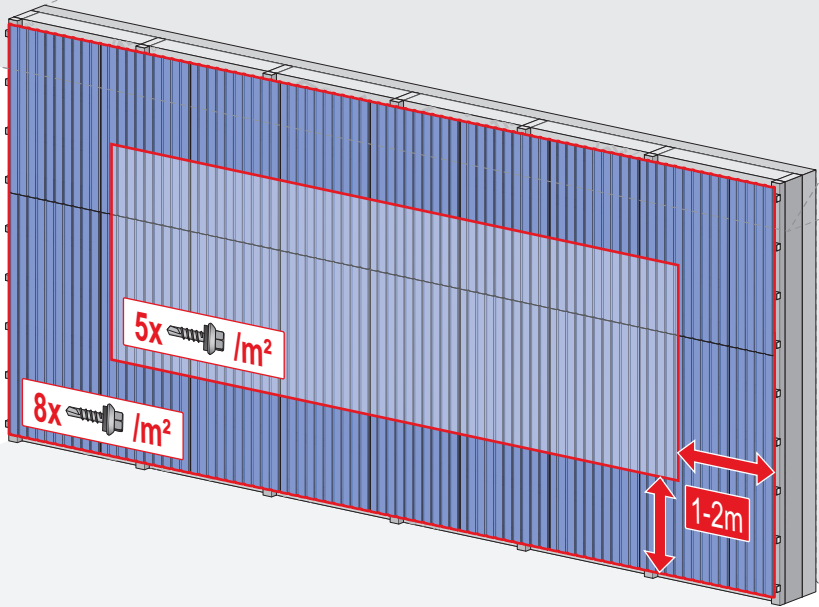
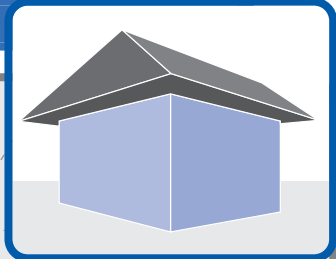

5b

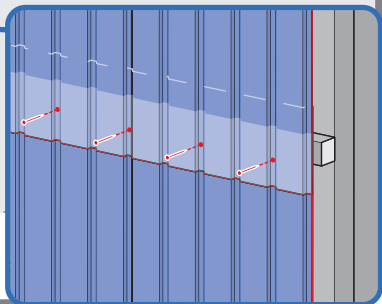
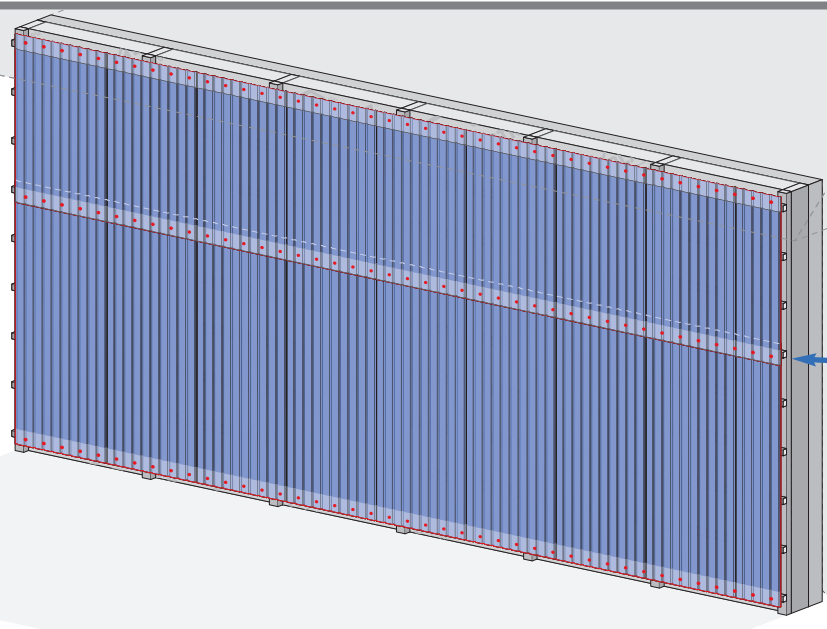

5c

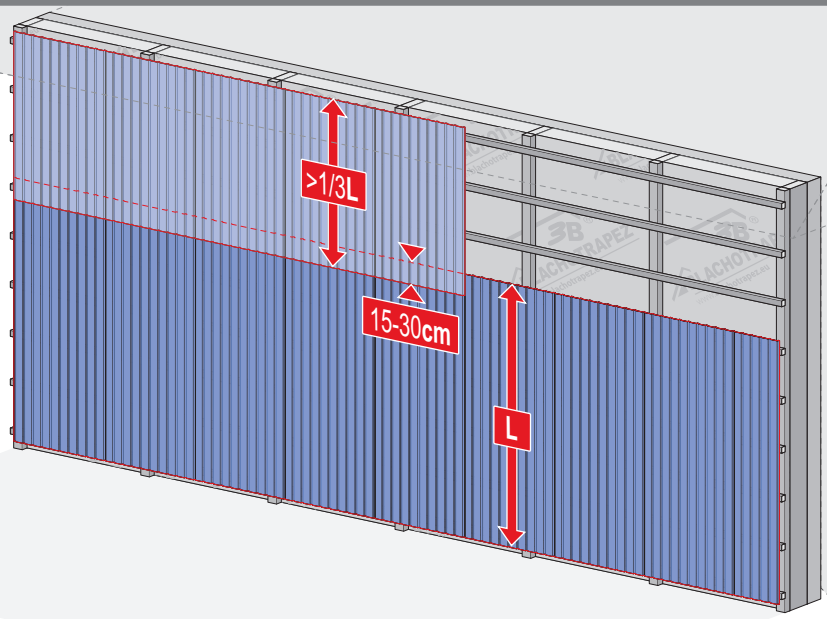

6a

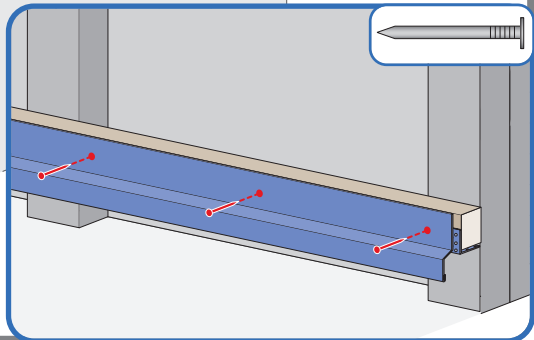
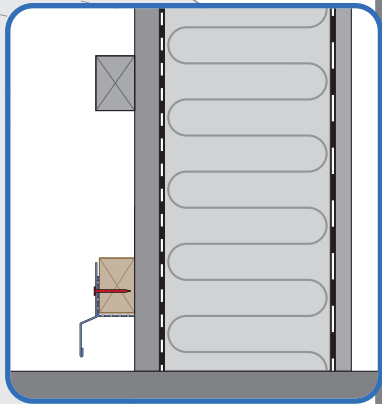
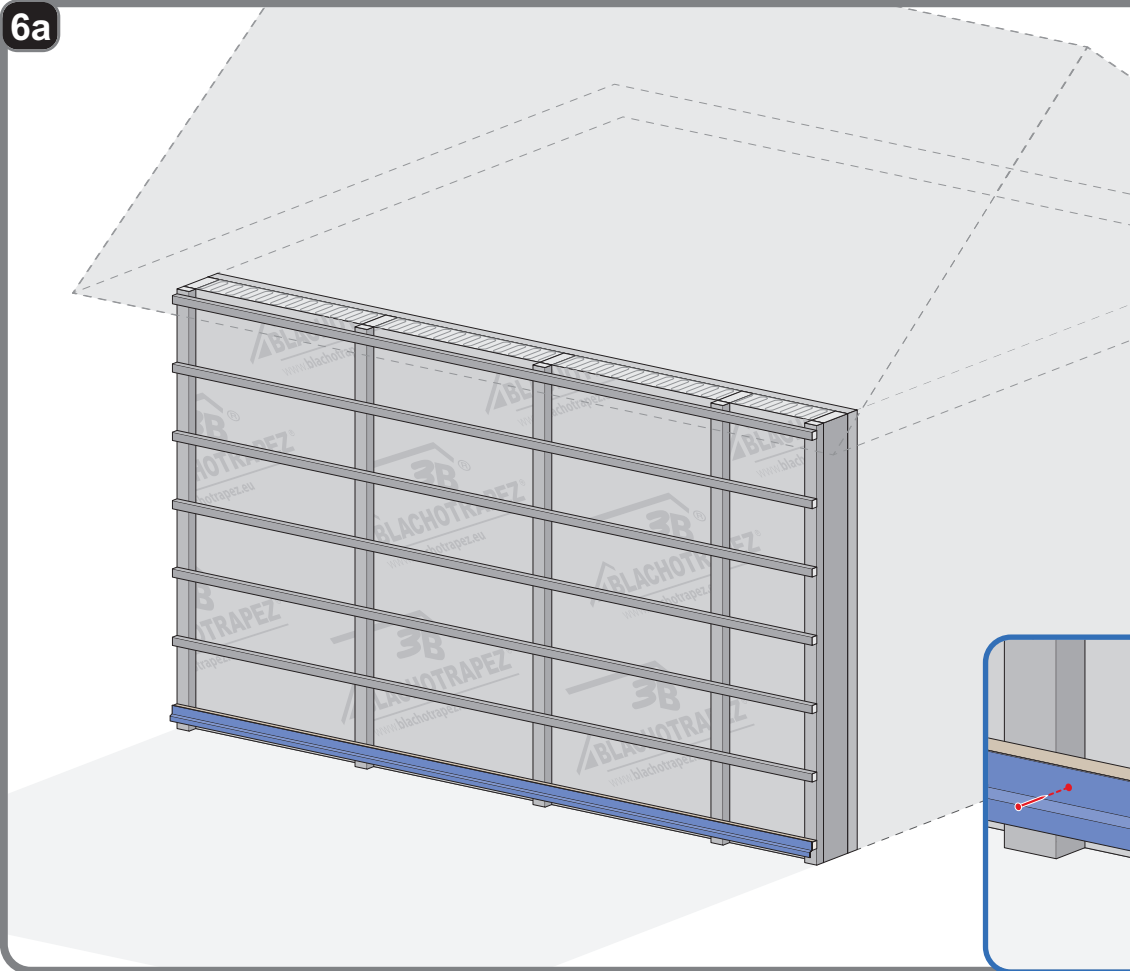
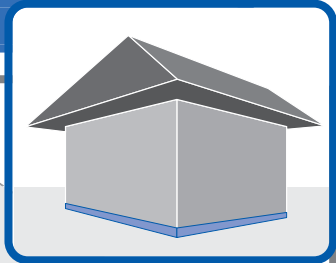

6b

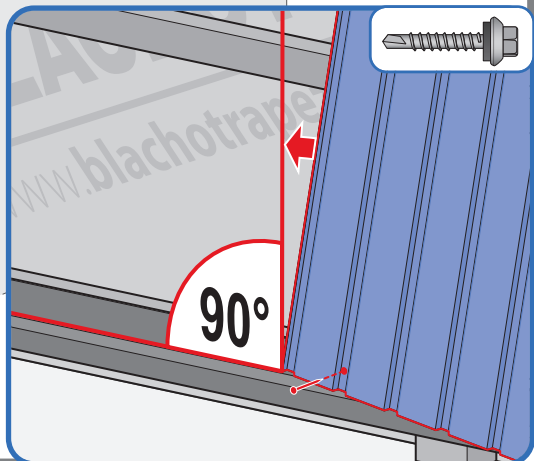
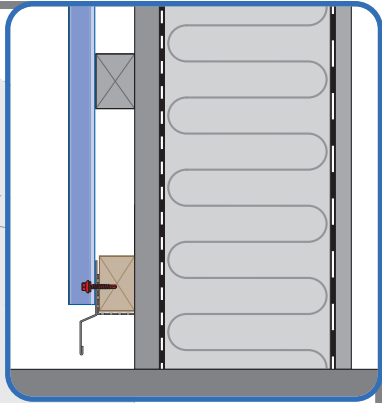
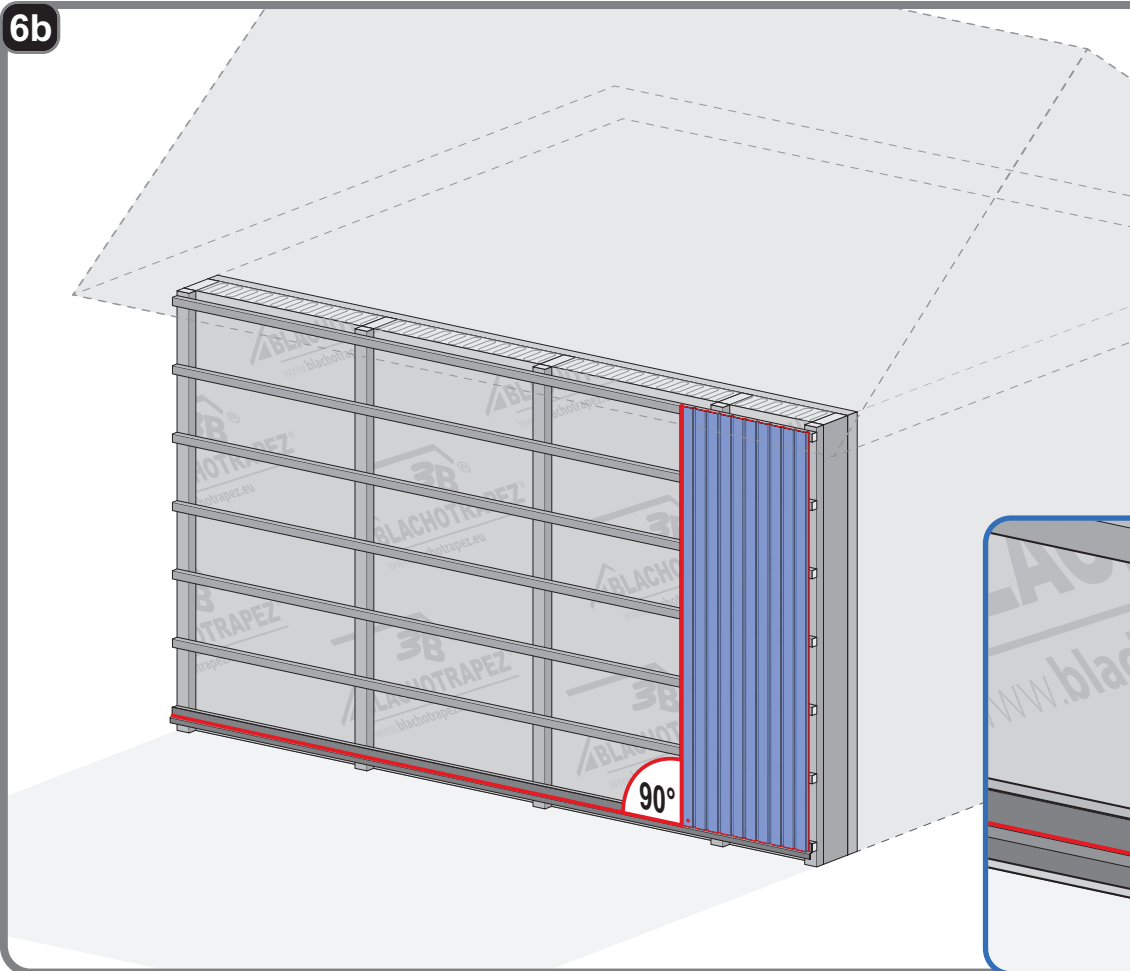

6c

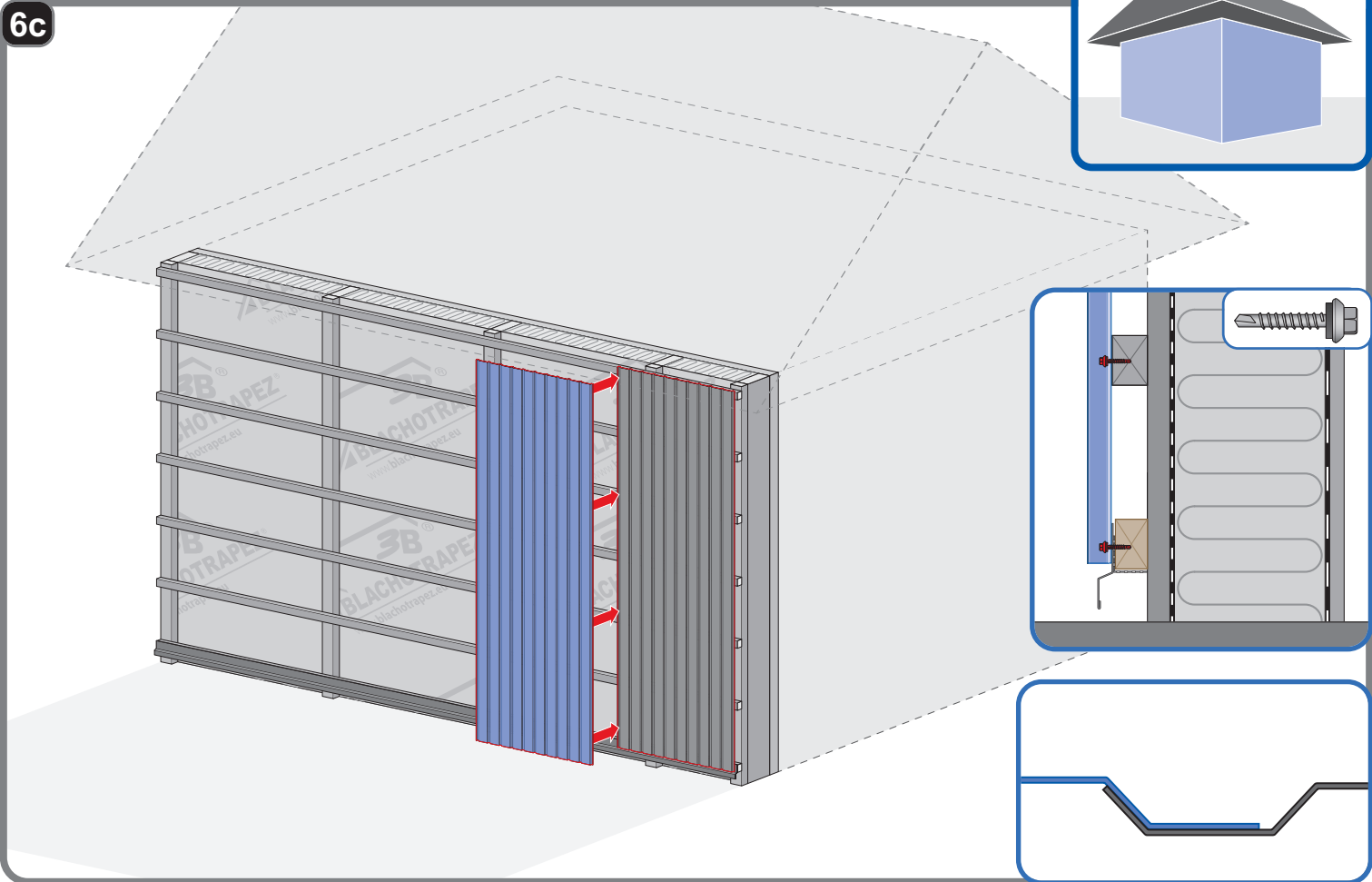
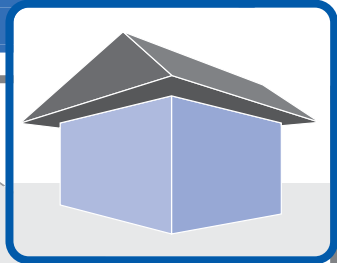

6d

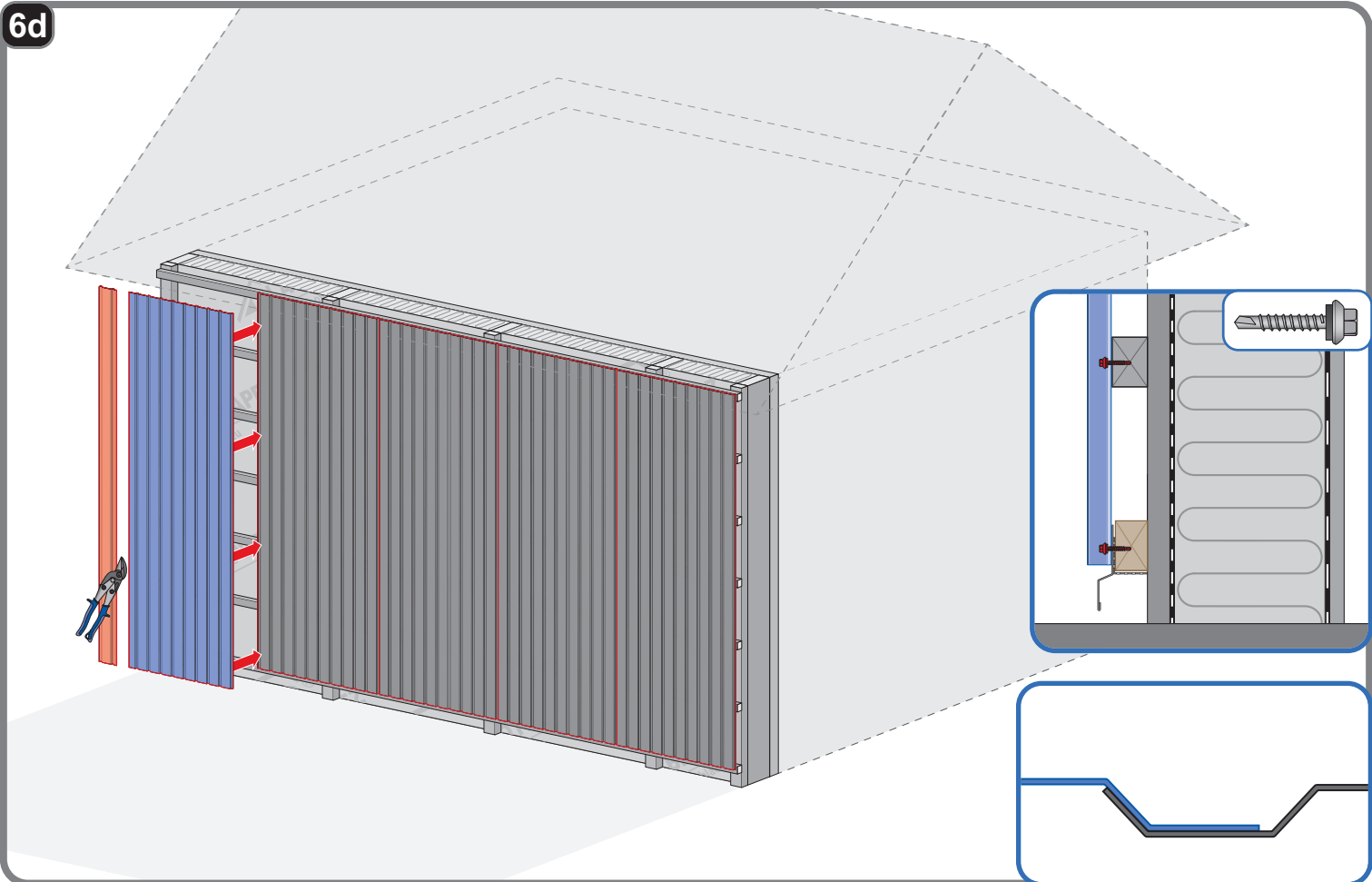

7a

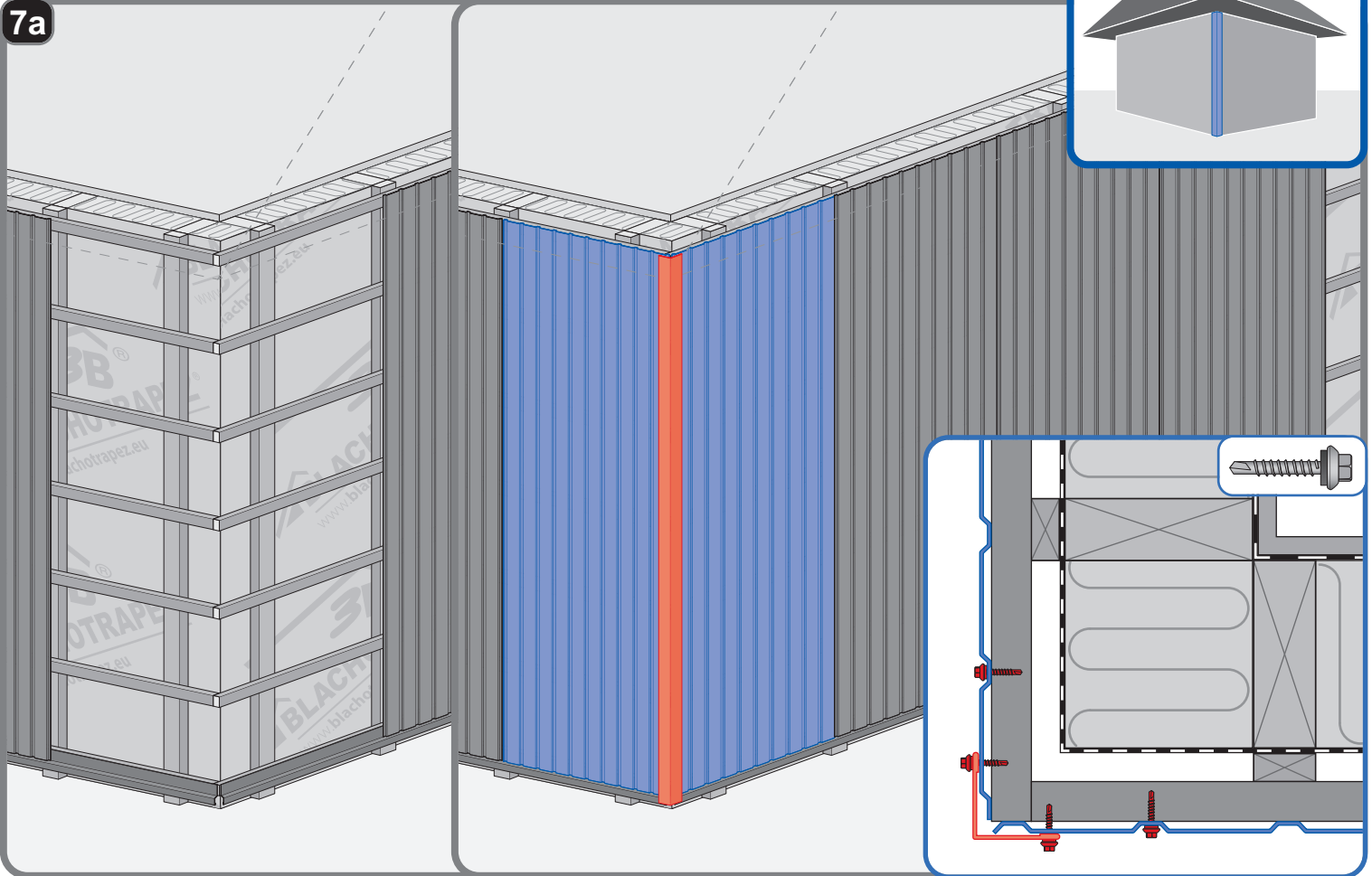

7b

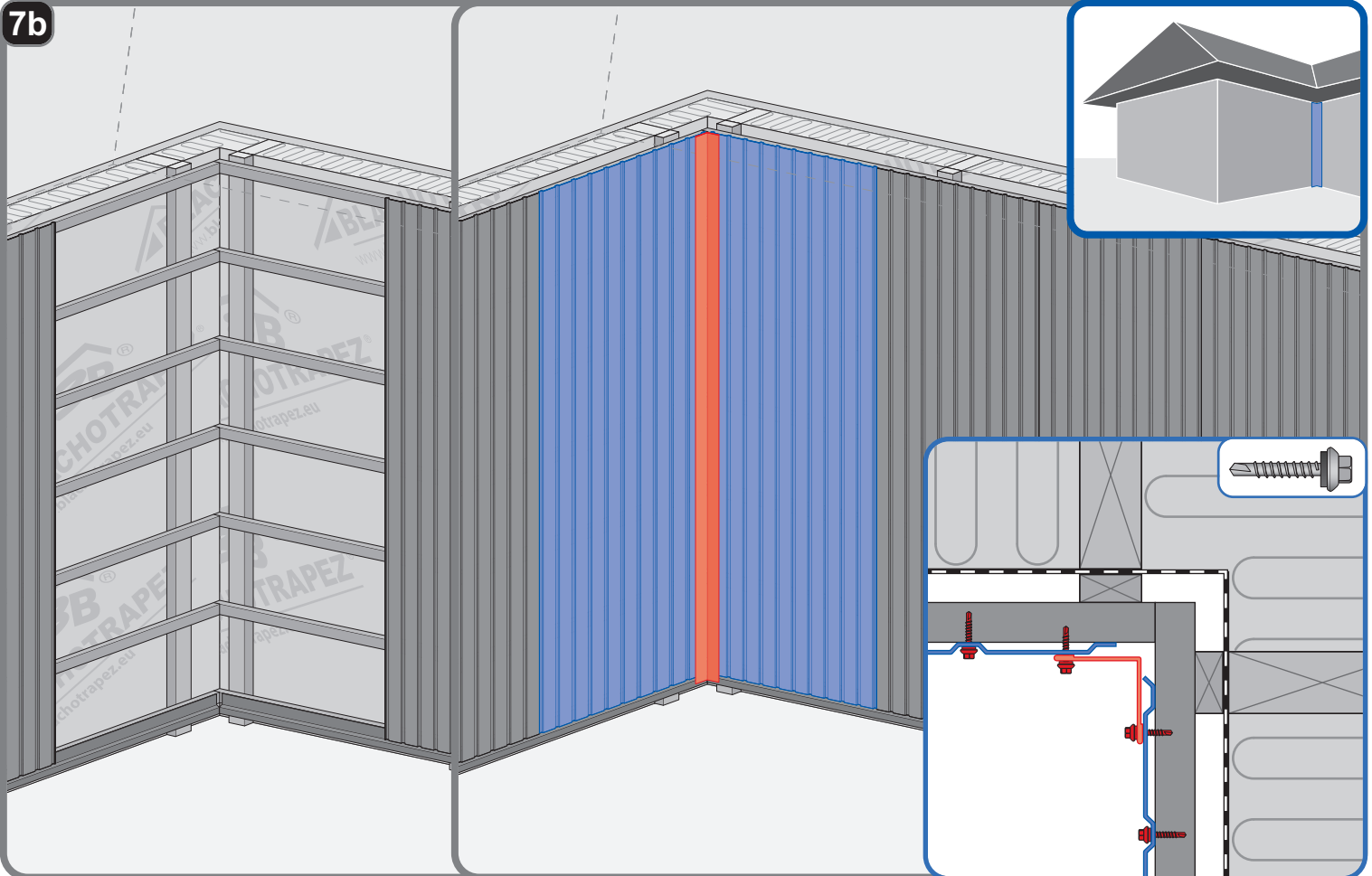

8a

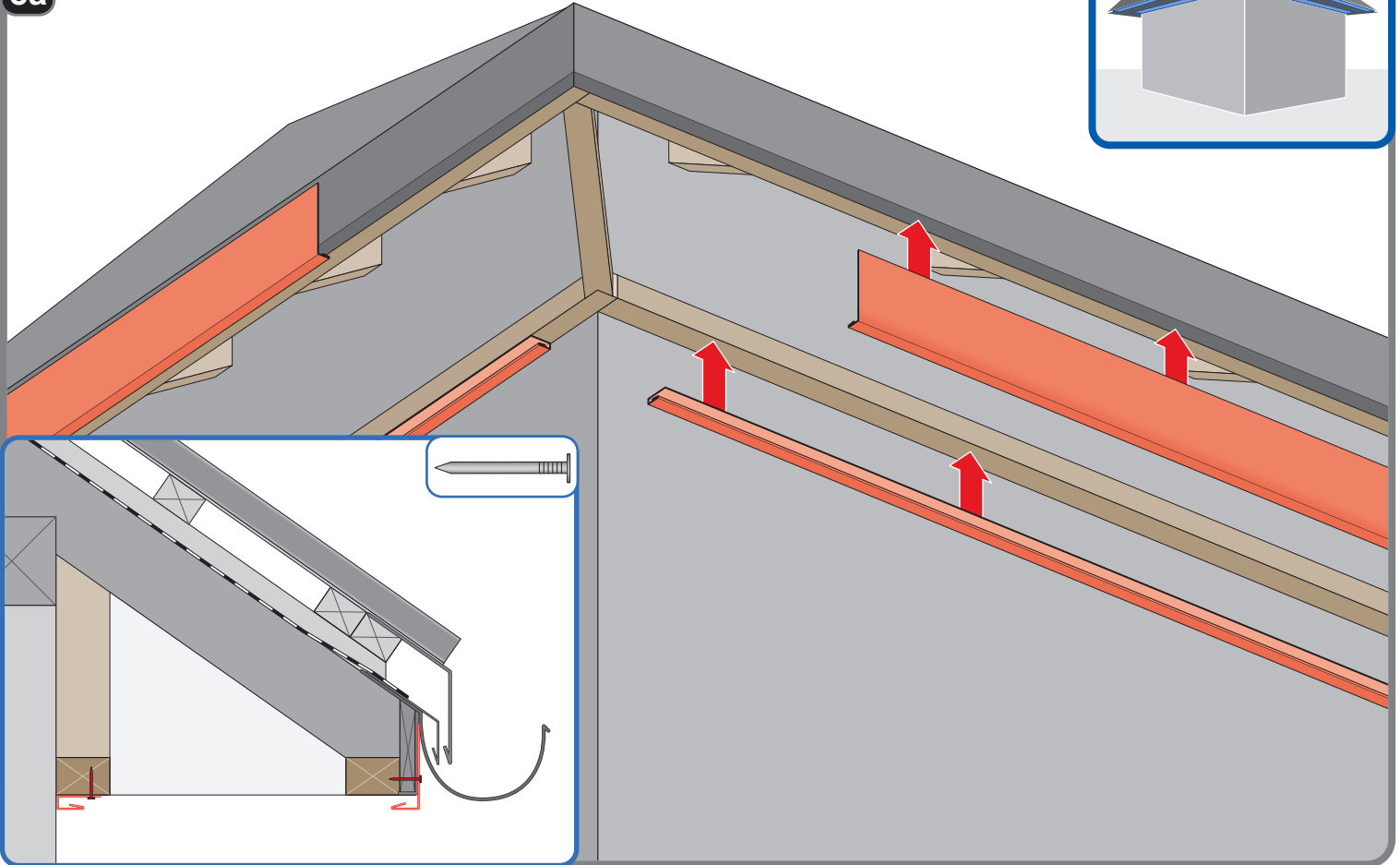
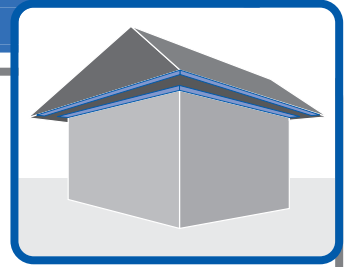

8b

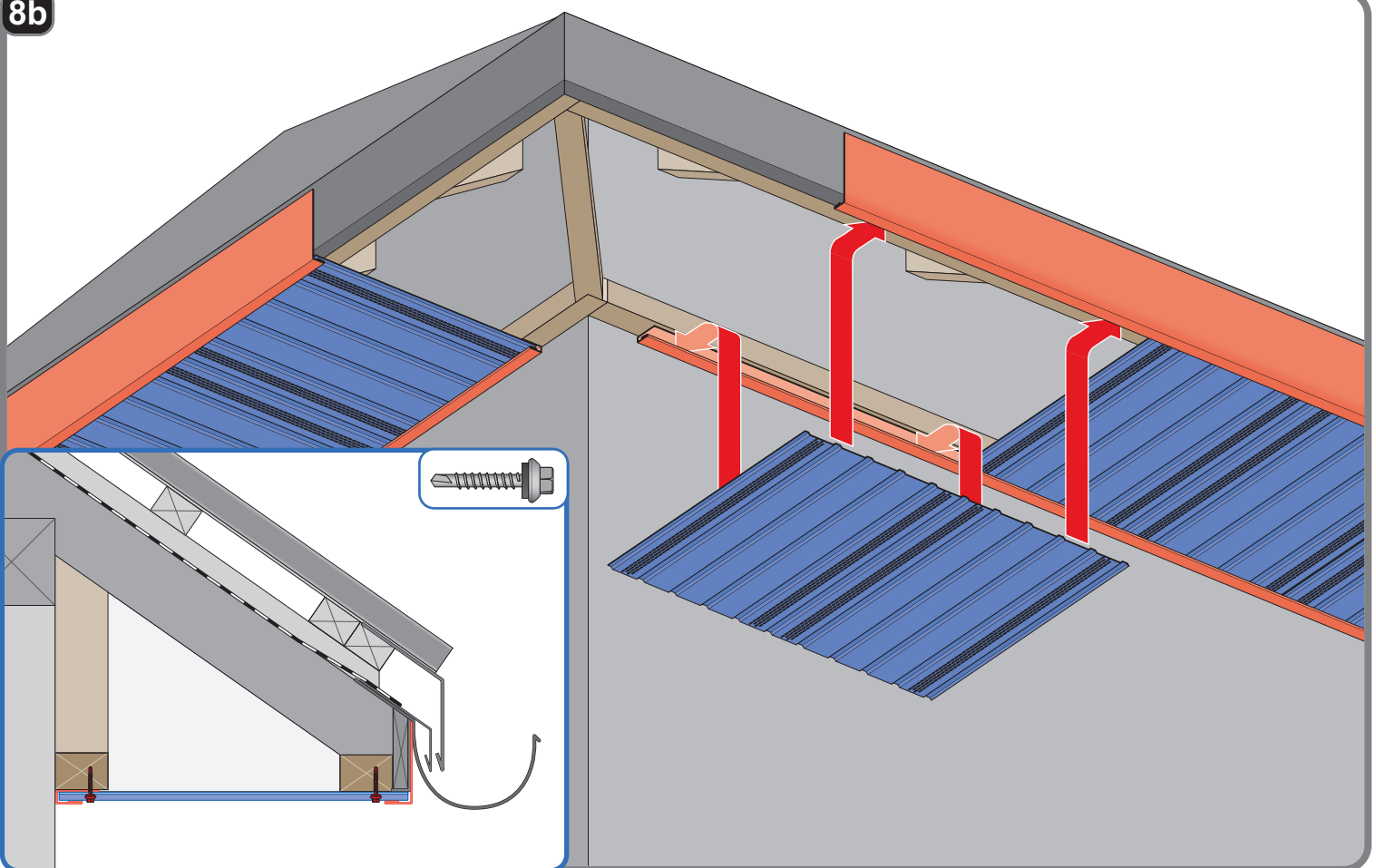

8c

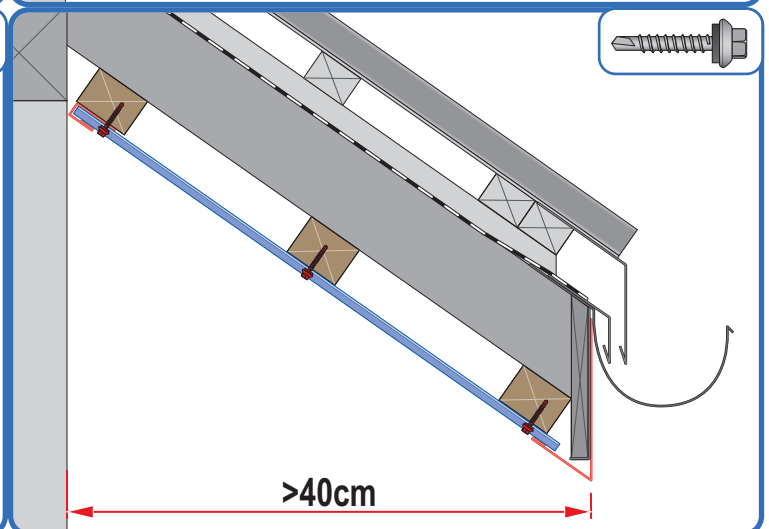
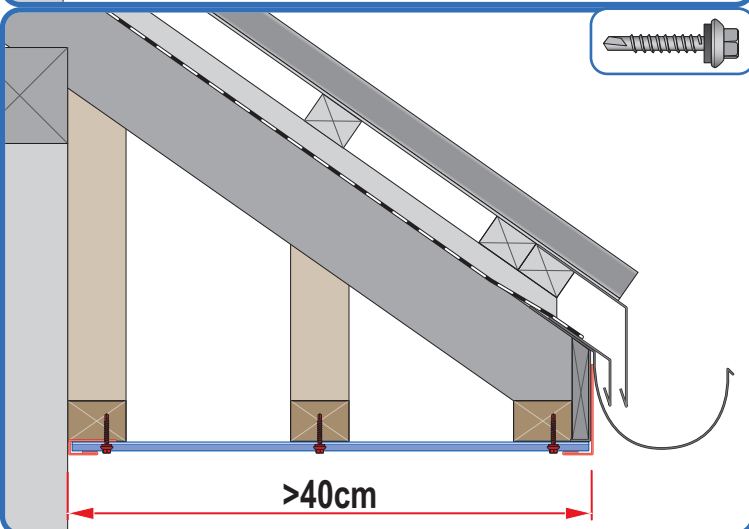
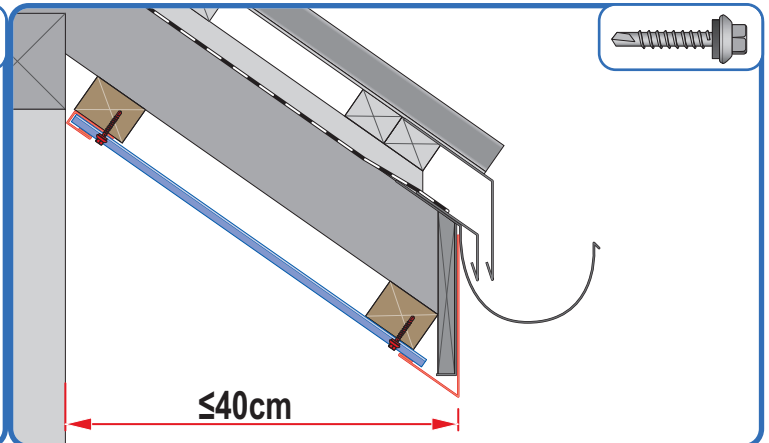
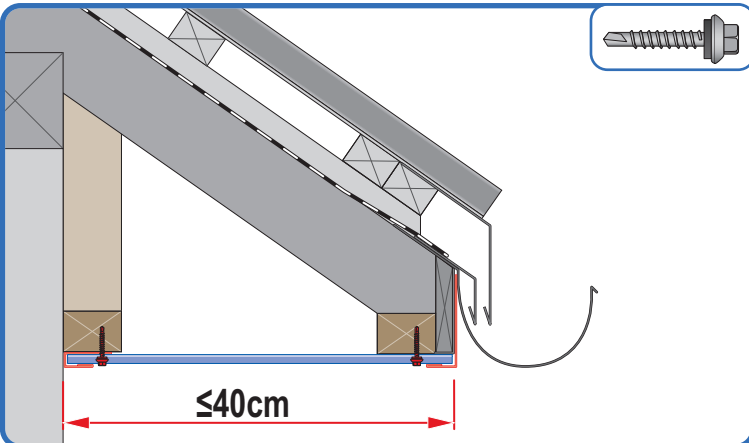
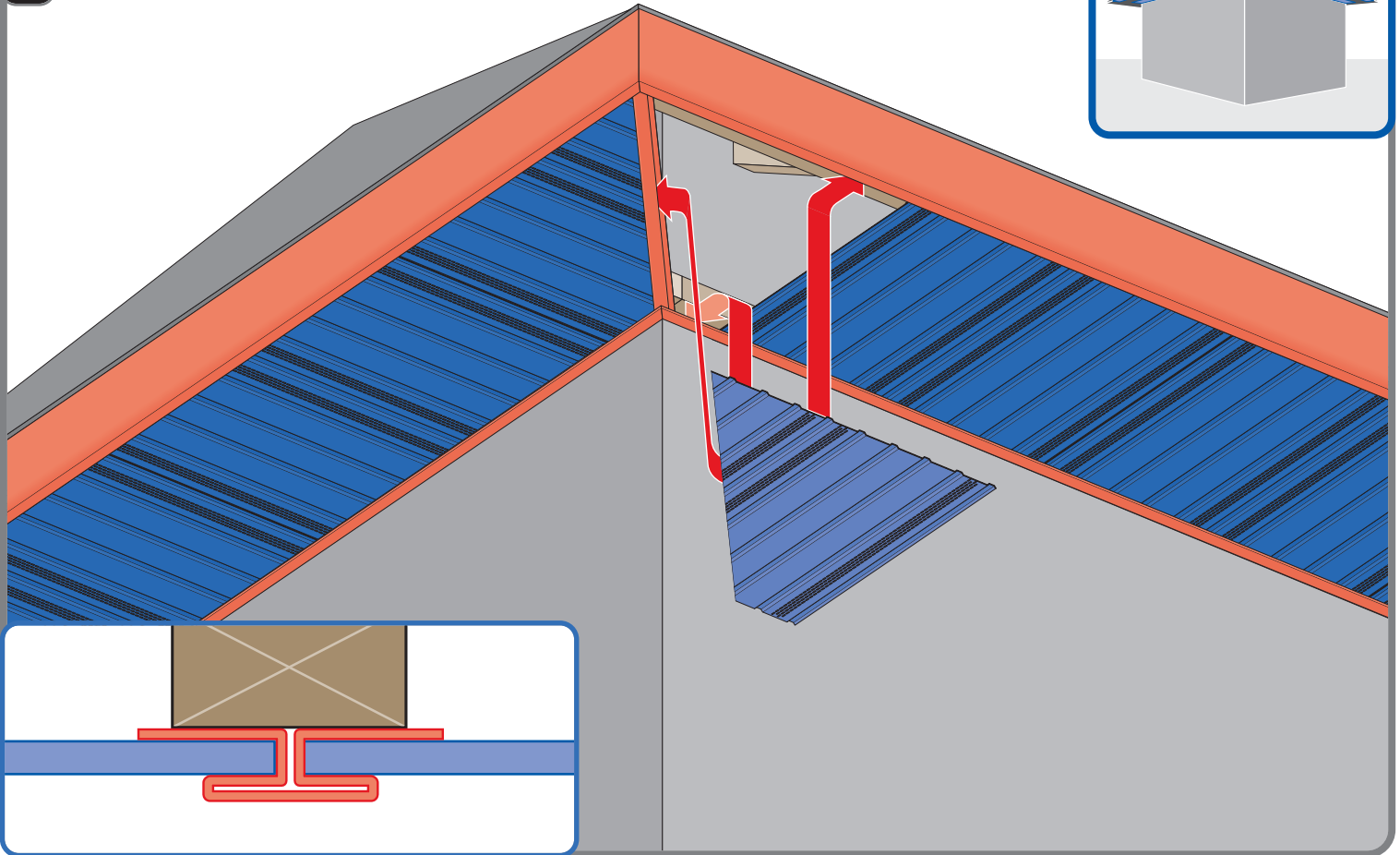
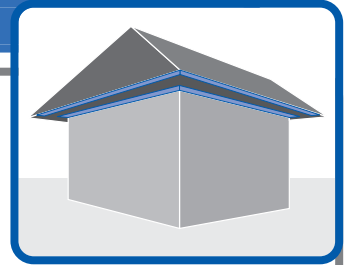

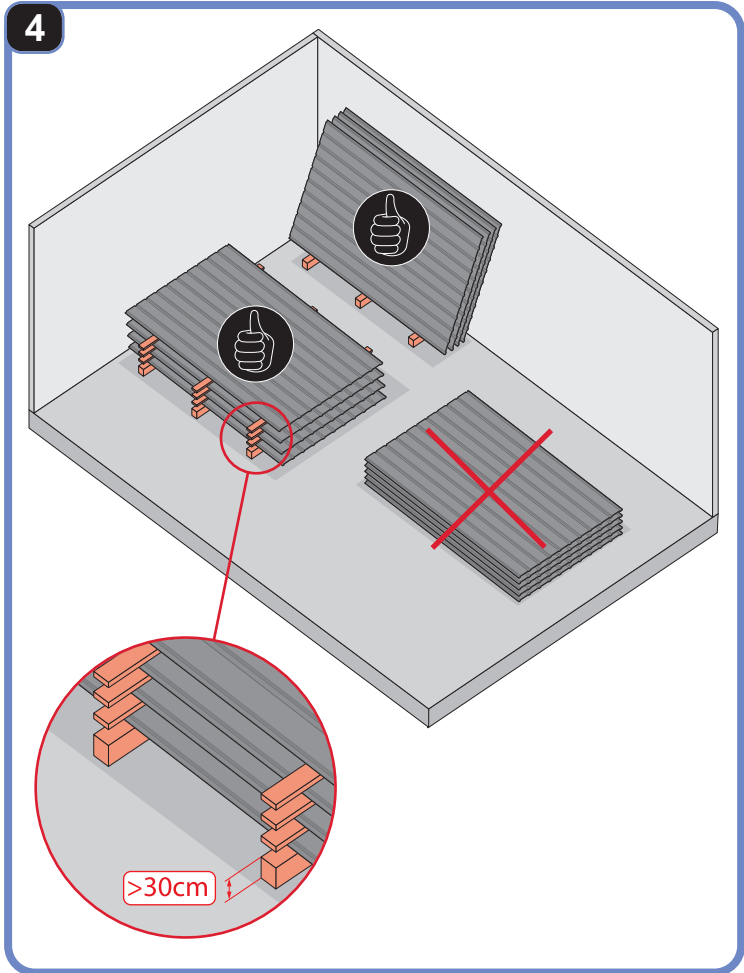
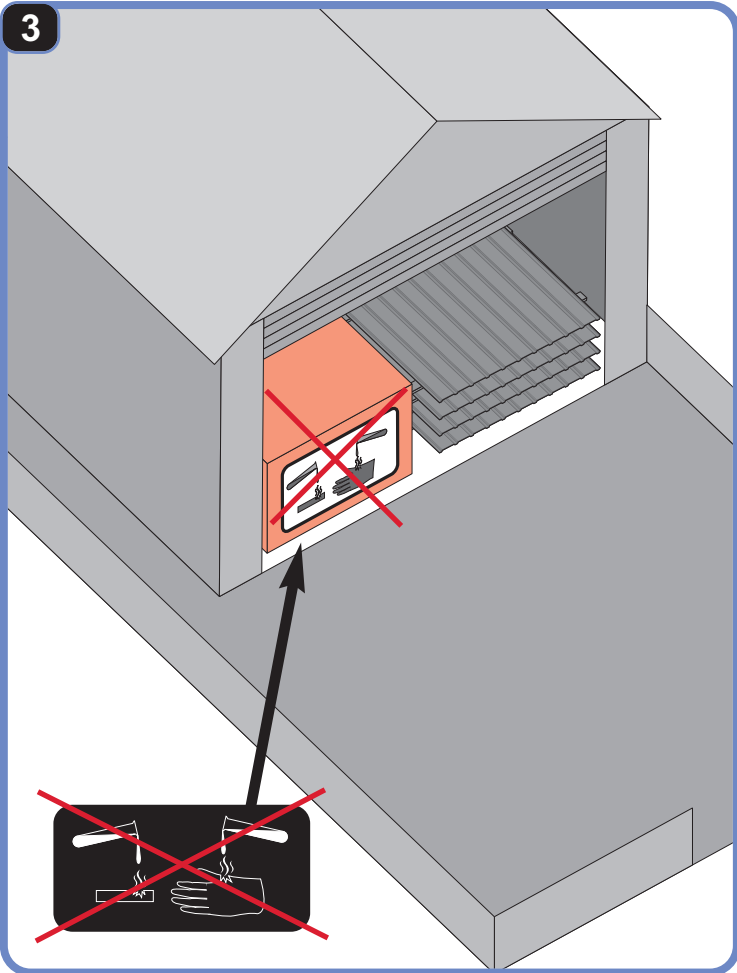
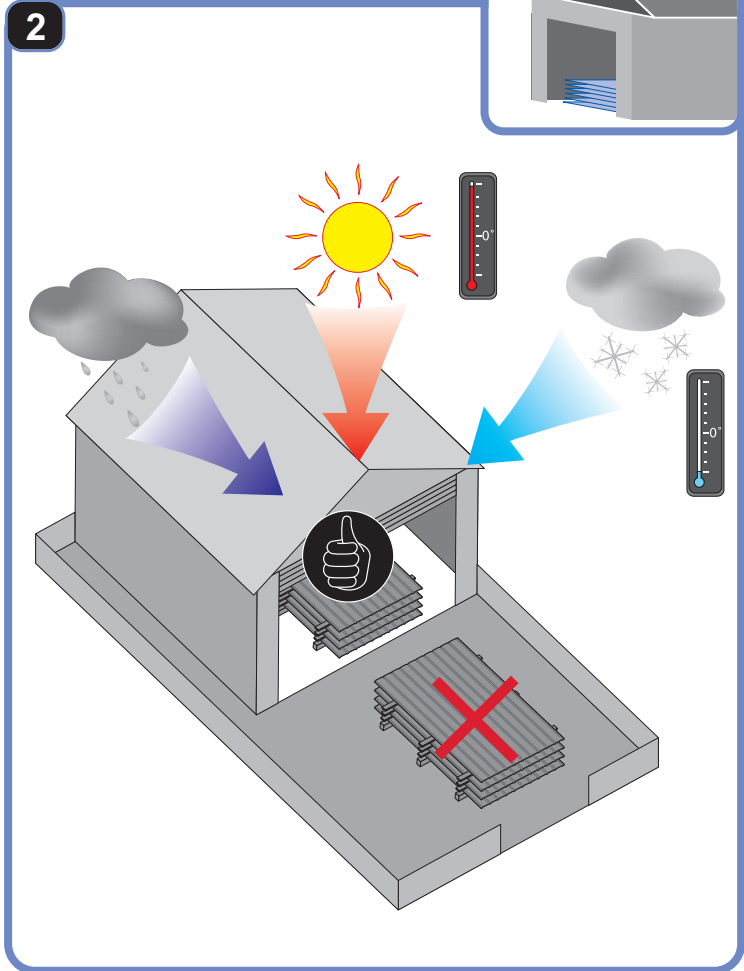
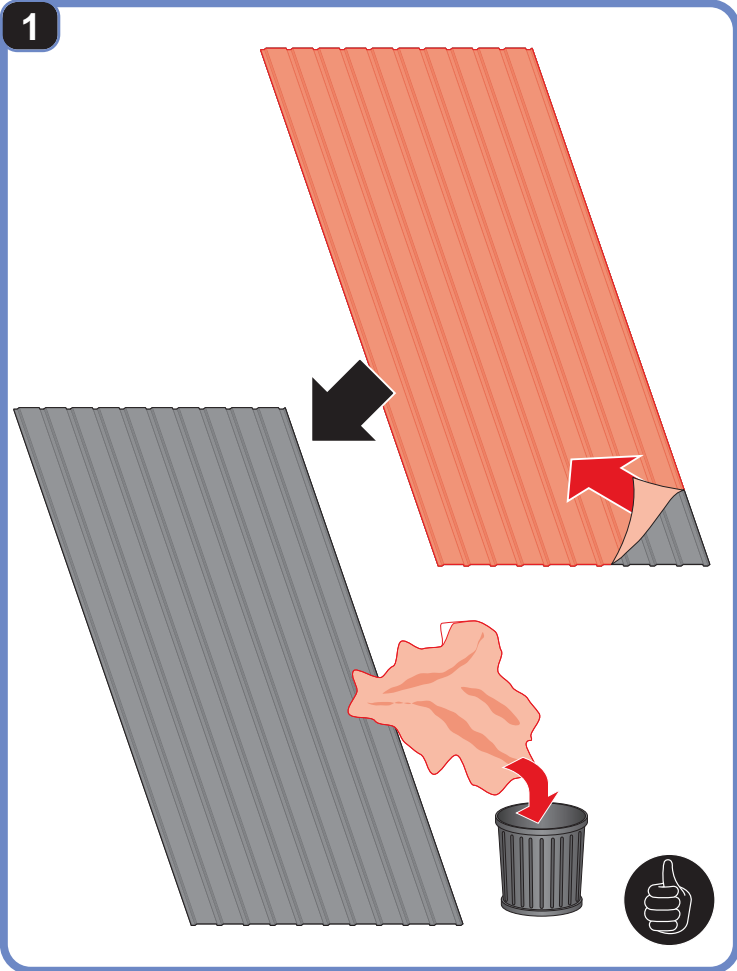

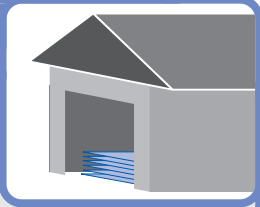

5

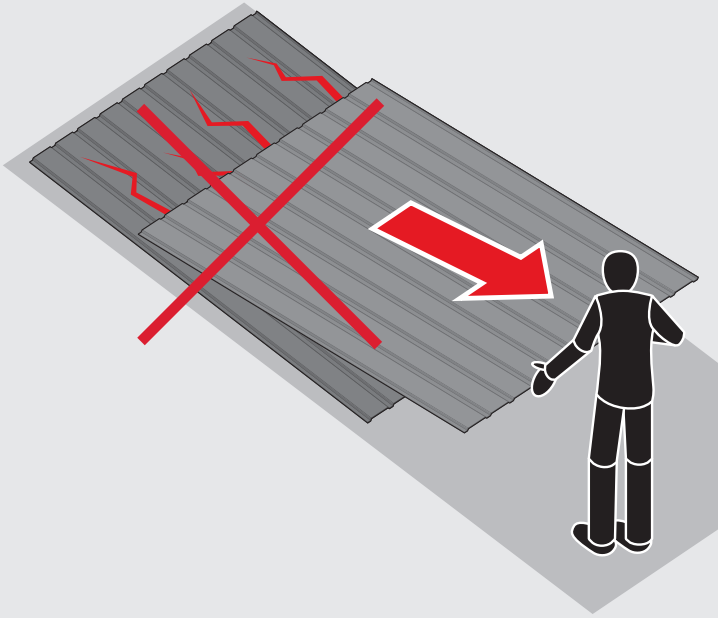

6

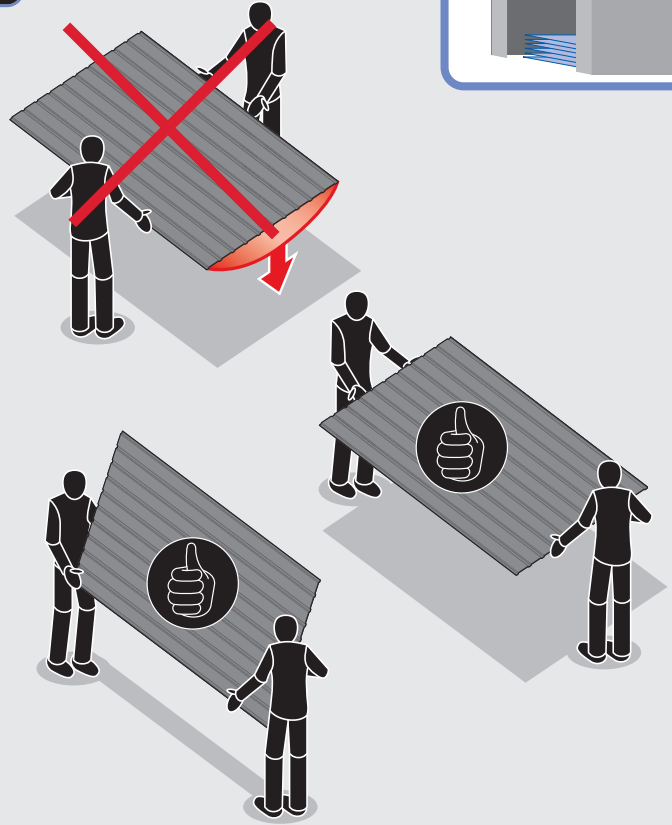

7

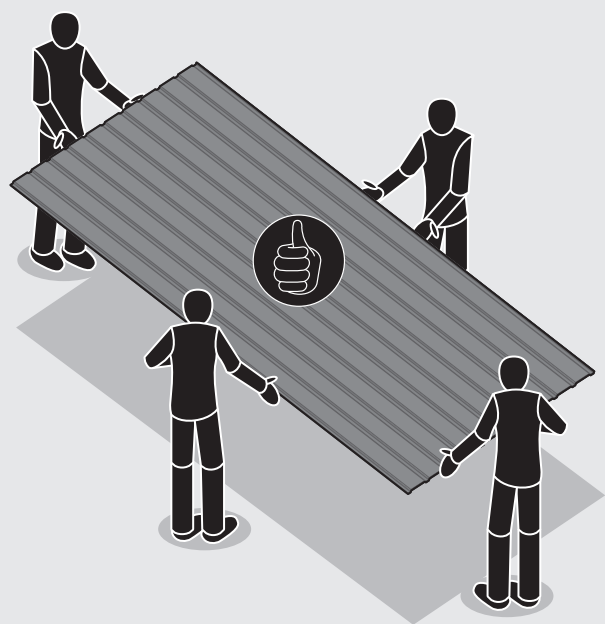
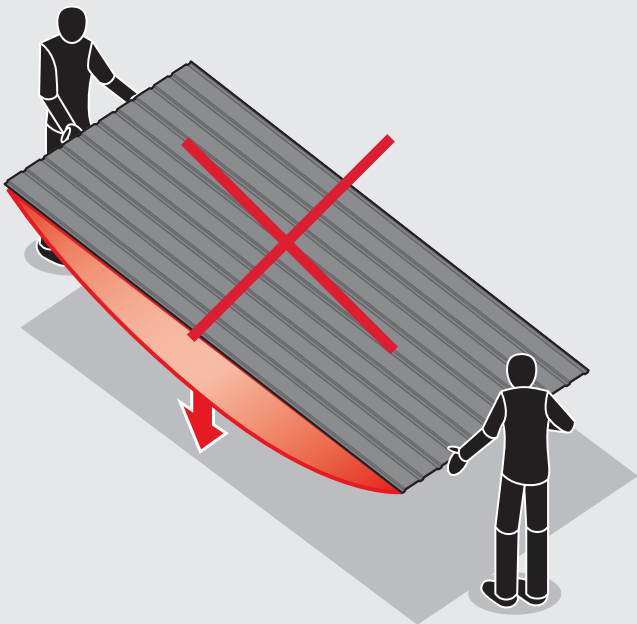



BLACHOTRAPEZ s. r. o.
Vojtaššákova 604
027 44 Tvrdošín
tel.: +4214353 92096
www.blachotrapez.sk
velkoobchod@blachotrapez.sk